



SERVICE PARTS LIST

BULLETIN NO.
54-07-2345

SPECIFY CATALOG NO. AND SERIAL NO. WHEN ORDERING PARTS		REVISED BULLETIN	DATE
12 VOLT M-SPECTOR 360™ (Digital Inspection Camera)			June 2011
CATALOG NO.	2314-20	SERIAL NUMBER	D60A
WIRING INSTRUCTION			

FIG.	PART NO.	DESCRIPTION OF PART	NO. REQ.
1	-----	O-Ring	(1)
2	-----	Upper Rotating Head	(1)
3	-----	Lower Rotating Head	(1)
4	-----	Top Housing	(1)
5	-----	LCD Lens	(1)
6	-----	LCD Cushion	(1)
7	-----	2 x 6 Plastite Screw	(17)
8	-----	1.7 x 5 Plastite Screw	(1)
9	-----	Rubber Washer	(4)
10	-----	2 x 4 Washer Head Screw	(4)
11	-----	LCD	(1)
12	-----	Rotate Head PCB	(1)
13	-----	Ferrite Bar Holder	(1)
14	-----	2 x 6 Washer Head Screw	(2)
15	-----	Battery Connector Block	(1)

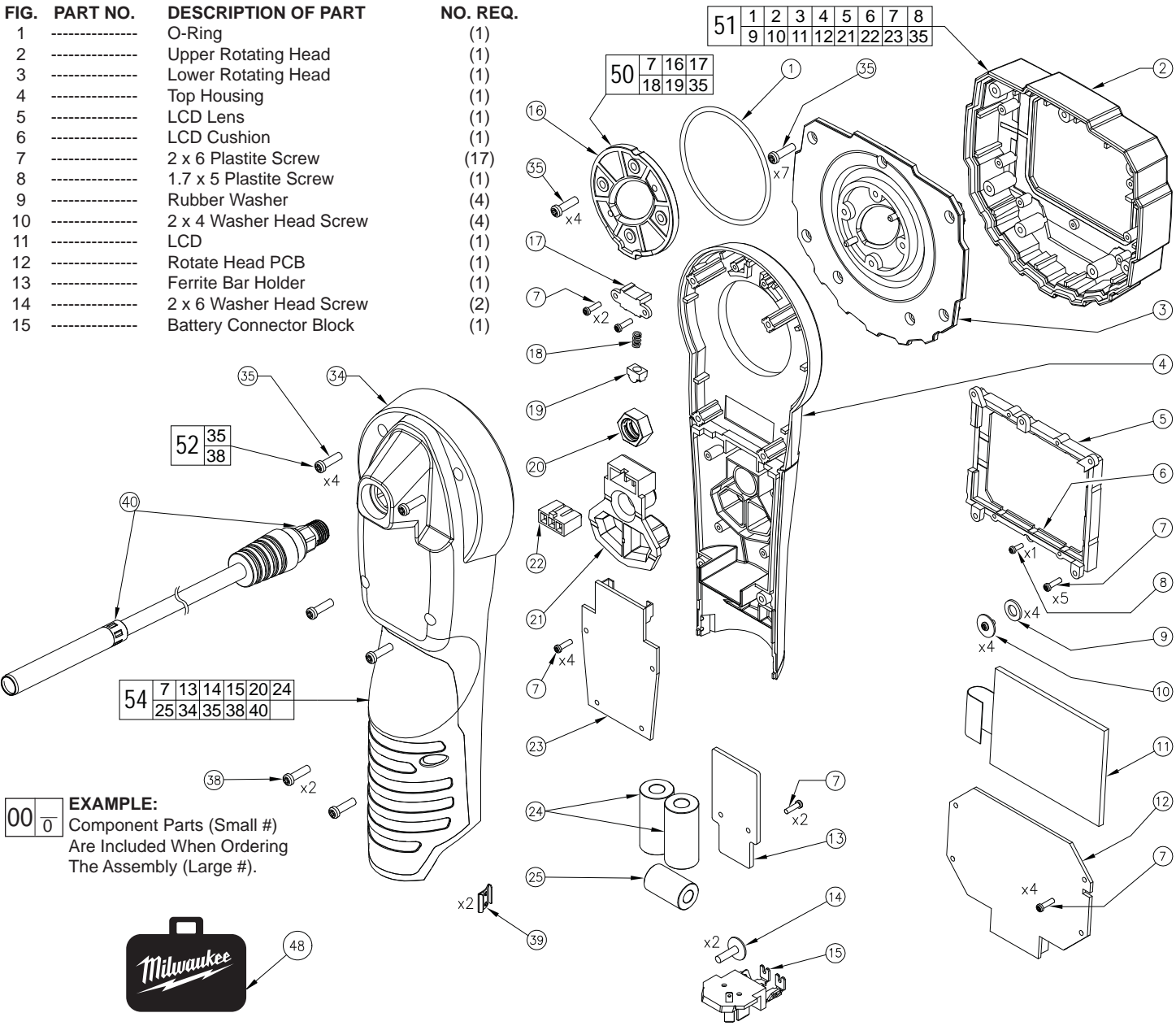

EXAMPLE:
Component Parts (Small #)
Are Included When Ordering
The Assembly (Large #).

FIG.	PART NO.	DESCRIPTION OF PART	NO. REQ.
16	-----	Rotary Stopper	(1)
17	-----	Detent Stud Holder	(1)
18	-----	Spring	(1)
19	-----	Detent Stud	(1)
20	-----	M10 Nut	(1)
21	-----	Key Pad	(1)
22	-----	Light Guide	(1)
23	-----	PCB	(1)
24	-----	Ferrite Bar	(2)
25	-----	Ferrite Bar	(1)
34	-----	Bottom Housing	(1)
35	-----	3 x 8 Plastite Screw	(15)
38	-----	2.6 x 8 Plastite Screw	(2)
39	42-70-0250	Housing Clip	(2)
40	-----	9' Camera Cable	(1)
42	43-74-0600	Hook (Not Shown)	(1)
43	44-26-0500	Magnet (Not Shown)	(1)

FIG.	PART NO.	DESCRIPTION OF PART	NO. REQ.
44	44-79-0200	Mirror (Not Shown)	(1)
45	43-56-1020	Ball Attachment (Not Shown)	(1)
46	12-20-2350	Service Nameplate (Not Shown)	(1)
47	10-20-2803	Warning Label (Not Shown)	(1)
48	42-55-2315	Carrying Case	(1)
50	14-20-1500	Rotating Screen Detent Kit	(1)
51	14-34-0925	Front Handle Assembly	(1)
52	45-04-1125	Housing Screw Set	(1)
54	14-34-1000	Rear Handle Assembly (2314-20)	(1)