



**NEW PRODUCTS
2019**



WOODWORKING & METALWORKING MACHINERY

2019 SPRING CATALOG



Features

#10-005 M1 | 1 HP dust collector

Totally enclosed, fan cooled, permanently lubricated motor. Designed for industrial applications with a continuous duty rating.

Heavy-duty construction, mounted on four swivel casters, allowing total mobility and stability.

Safety switch with key. Unit cannot be started when key is removed from the switch.

Precision aluminum spin-balanced impeller for smooth operation and minimal noise.

Reusable clear plastic collector bag for improved dust collection efficiency.

5" heavy-duty PVC hose between body of fan and collector.

Collector body mounted on 3 heavy-duty support rods.

Washable with 2 micron filter bag (not included on "CF" canister filter model).

Quick-release bag clamps with metal straps.

Intake screen prevents larger pieces from jamming in the impeller.



Inlet diameter	(1) 4" (102 mm)
Airflow capacity	700 cfm
Blower wheel diameter	10" (254 mm)
Sound rating	75 to 80 dB
Bag diameter	15" (381 mm)
Bag capacity	20 gal. (90.9 L)
Static pressure (without bag)	6 5/32" of water
Overall dimensions (l x w x h)	29 1/8" x 16 1/2" x 56 1/2" (740 x 420 x 1430 mm) - 10-005A 29 1/8" x 16 1/2" x 61" (740 x 420 x 1550 mm) - 10-005AS 29 1/8" x 16 1/2" x 49 1/4" (740 x 420 x 1250 mm) - 10-005ASCF
Motor	1 HP, 110 V, 1 Ph, 7 A
Weight	55 lbs (25 kg) - 10-005A 61 lbs (30 kg) - 10-005ACF 72 lbs (33 kg) - 10-005ASCF

Optional accessories

2 micron filter bag (#10-015).

Clear plastic collector bag (#10-016).

4" x 2 1/2" reducer (#10-072).

4" x 2 1/2" reducer (#10-073).

4" x 2 1/2" reducer (#10-074).

Dust hood 8 1/4" x 8 1/4" x 4" (#10-076).

Dust hood 10 1/4" x 8 1/2" x 4" (#10-077).

Floor sweeps (#10-078).

Window type collector bag (#10-125).

4" x 50" polyethylene flexible hose (#10-130).

4" x 50" grey flexible hose (#10-130G).

Remote control (#10-150R).

4" x 10" polyethylene flexible hose (#10-410).

Optional accessories

4" blast gate (#10-080).

Universal dust hood (#10-081).

4" T-fitting (#10-082).

4" Y-fitting (#10-083).

4" elbows (#10-084).

4" splice (#10-085).

4" x 2 1/2" reducer (#10-086).

4" x 10" dust hood (#10-087).

4" cap (#10-088).

4" hose clamp (#10-089).

Bag clamp (#10-092).

Accessory kit for dust collector - 1 machine hook-up (#10-100).

General International

#10-030CF M1 | 1 HP dust collector

Features

Powerful 1 HP motor features sealed bearing and shaft for quiet, long-lasting operation.

Safety switch with key. Unit cannot be started when key is removed from the switch.

Precision spin-balanced impeller for smooth operation and minimal noise.

Reusable clear plastic collector bag for improved dust collection efficiency.

Collector body mounted on 3 heavy-duty supports.

Quick-release bag clamps with metal straps.

Equipped with high efficiency 1 micron canister filter.

Large 7" rubber wheels for exceptional stability and smooth mobility.



Inlet diameter	4" (102 mm)
Airflow capacity	506 cfm
Filter area	20.33 sq.ft.
Sound rating	80-85 dB
Blower wheel diameter	10" (254 mm)
Static pressure	6 3/4" of water
Canister filter size	14 1/2" x 11 3/4" (370 x 300 mm)
Overall dimensions (l x w x h)	31 1/8" x 18 7/8" x 47 5/8" (790 x 480 x 1210 mm)
Motor	1 HP, 110 V, 7 A
Weight	67 lbs (31 kg)

Optional accessories

Canister filter (#10-006S).

Clear plastic collector bag (#10-016).

4" x 2 1/2" reducer (#10-072).

4" x 2 1/2" reducer (#10-073).

4" x 2 1/2" reducer (#10-074).

Dust hood 8 1/4" x 8 1/4" x 4" (#10-076).

Dust hood 10 1/4" x 8 1/2" x 4" (#10-077).

Floor sweeps (#10-078).

4" blast gate (#10-080).

Universal dust hood (#10-081).

4" T-fitting (#10-082).

4" Y-fitting (#10-083).

4" elbows (#10-084).

4" splice (#10-085).

4" x 2 1/2" reducer (#10-086).

4" x 10" dust hood (#10-087).

► Powerful 1 HP motor features sealed bearing and shaft for quiet, long lasting operation.

4" x 10" dust hood (#10-087).

4" cap (#10-088).

4" hose clamp (#10-089).

Bag clamp (#10-092).

Accessory kit for dust collector - 1 machine hook-up (#10-100).

Window type collector bag (#10-125).

4" x 50" polyethylene flexible hose (#10-130).

4" x 50" grey flexible hose (#10-130G).

Remote control (#10-150R).

4" x 10" polyethylene flexible hose (#10-410).

General International

Features

Totally enclosed, fan cooled, permanently lubricated motor. Designed for industrial applications with a continuous duty rating.

Heavy-duty construction, mounted on four swivel casters, allowing total mobility and stability.

Safety switch with key. Unit cannot be started when key is removed from the switch.

Precision spin-balanced impeller for smooth operation and minimal noise.

Reusable clear plastic collector bag for improved dust collection efficiency.

5" heavy-duty PVC hose between body of fan and collector.

Collector body mounted on 3 heavy-duty rods.

Equipped with 2 micron filter bag. (Not included on "CF" canister filter model).

Quick-release bag clamps with metal straps.

Intake screen prevents larger pieces from jamming in the impeller.

#10-105 M1 | 1 1/2 HP dust collector



Inlet diameter	(1) 6" (152 mm) (or 2) 4" (102 mm) with Y fitting inlet
Airflow capacity	1250 cfm
Blower wheel diameter	12 3/4" (323 mm)
Sound rating	80 to 85 dB
Bag diameter	20" (508 mm)
Bag capacity	42 gallon (190.9 L)
Static pressure (without bag)	9" of water
Overall dimensions (l x w x h)	38" x 31 1/2" x 76" (970 x 800 x 1930 mm) - 10-105A 38" x 31 1/2" x 71" (768 x 525 x 1800 mm) - 10-105ACF
Motor	1 1/2 HP, 110/220 V, 1 Ph, 14/7 A
Weight	106 lbs (48 kg) - 10-105A 130 lbs (59 kg) - 10-105ACF

ALSO AVAILABLE:

10-105CF M1
Same specifications but with 1 micron canister filter (#10-106) replacing filter bag & mounting hardware.



Optional accessories

4" x 2 1/2" reducer (#10-072).

4" x 2 1/2" reducer (#10-073).

4" x 2 1/2" reducer (#10-074).

Dust hood 8 1/4" x 8 1/4" x 4" (#10-076).

Dust hood 10 1/4" x 8 1/2" x 4" (#10-077).

Floor sweeps (#10-078).

4" blast gate (#10-080).

Universal dust hood (#10-081).

4" T-fitting (#10-082).

4" Y-fitting (#10-083).

4" elbows (#10-084).

4" splice (#10-085).

4" x 2 1/2" reducer (#10-086).

4" x 10" dust hood (#10-087).

4" cap (#10-088).

4" or 5" hose clamp (#10-089/10-090).

Bag clamp (#10-093).

Accessory kit for dust collector 1 machine hook-up (#10-100).

Clear plastic collector bag (#10-120).

Window type collector bag (#10-125).

4" x 50" polyethylene flexible hose (#10-130).

4" x 50" grey flexible hose (#10-130G).

Remote control (#10-150R).

Fire protection cage (#10-420).

Features

- Heavy-duty motor design with a continuous duty rating for industrial applications.
- Equipped with totally enclosed, fan cooled, permanently lubricated motor.
- Heavy-duty base, mounted on four swivel casters for total mobility and stability.
- Precision spin-balanced aluminum impeller for smooth operation, minimal noise and to reduce the risk of sparking.
- Equipped with 2 micron filter bag (not included on "CF" canister filter model).
- Quick-release bag clamps with metal straps.
- Safety switch with key, prevents unit from being started when key is removed.
- Heavy-duty collection bag made from extra thick, transparent, recyclable plastic.



#10-110 M1 | 2HP dust collector

Inlet diameter	(1) 6" (152 mm) / (or 2) 4" (102 mm)
Airflow capacity	1550 cfm
Blower wheel diameter	12 3/4" (323 mm)
Sound rating	80 to 90 dB
Bag diameter	20" (508 mm)
Bag capacity	42 gallon (190.9 l)
Static pressure (without bag)	11 1/4" of water
Overall dimensions (L x W x H)	39 3/8" x 31 1/2" x 74 3/4" (1000 x 800 x 2000 mm) - 10-110A 39 3/8" x 31 1/2" x 66 3/4" (1000 x 800 x 1746 mm) - 10-110ACF
Motor M1	2 HP, 120 V, 1 Ph, 15 A
Motor M2	2 HP, 600 V, 3 Ph, 2.6 A
Weight	132 lbs (60 kg) - 10-110A 141 lbs (64 kg) - 10-110ACF

Optional accessories

- 4" x 2 1/2" reducer (#10-072).
- 4" x 2 1/2" reducer (#10-073).
- 4" x 2 1/2" reducer (#10-074).
- Dust hood 8 1/4" x 8 1/4" x 4" (#10-076).
- Dust hood 10 1/4" x 8 1/2" x 4" (#10-077).
- Floor sweeps (#10-078).
- 4" blast gate (#10-080).
- Universal dust hood (#10-081).
- 4" T-fitting (#10-082).
- 4" Y-fitting (#10-083).
- 4" elbows (#10-084).
- 4" splice (#10-085).
- 4" x 2 1/2" reducer (#10-086).
- 4" x 10" dust hood (#10-087).

ALSO AVAILABLE:

10-110CF M1
Same specifications but with 1 micron canister filter (#10-106) replacing filter bag & mounting hardware.



10-110HF M1
Same specifications but with 0.3 micron HEPA canister filter (#10-106HF) replacing filter bag & mounting hardware.



General International

#10-210 M1 | 2.5 HP Dust collector

Features

Heavy-duty motor design with a continuous duty rating for industrial applications.

Equipped with a totally enclosed, fan cooled, permanently lubricated motor.

Heavy-duty base, mounted on four swivel casters for total mobility and stability.

Precision spin-balanced aluminum impeller for smooth operation, minimal noise and to reduce the risk of sparking.

Equipped with 2 micron filter bags (not included on "CF" canister filter model).

Quick-release bag clamps with metal straps.

Safety switch with key, prevents unit from being started when key is removed.

Heavy-duty collection bags made from extra thick, transparent, recyclable plastic.



CF

Inlet diameter	(1) 6" (152 mm) / (or 3) 4" (102 mm)
Airflow capacity	2280 cfm
Blower wheel diameter	12" (305 mm)
Sound rating	80 to 95 dB
Bag diameter	20" (508 mm)
Bag capacity	83 gallon (377 l)
Static pressure	15 9/16" of water
Overall dimensions (L x W x H)	60" x 32 5/8" x 76" (1520 x 830 x 1930 mm) - 10-210A 61" x 21 5/8" x 74 3/4" (1550 x 550 x 1900 mm) -
Motor	M1 10-210ACF 2.5 HP, 120 V, 1 Ph, 18 A
Weight	165 lbs (75 kg) - 10-210A

ALSO AVAILABLE:

10-210CF M1

Same specifications but with 1 micron canister filters (#10-106) replacing filter bags & mounting hardware.



Window type collector bag (#10-125).

4" x 50" polyethylene flexible hose (#10-130).

4" x 50" grey flexible hose (#10-130G).

5" or 6" x 50" polyethylene flexible hose (#10-135/10-140).

Accessory kit for dust collector 2 machine hook-up (#10-200).

Features

Forced opening line interrupt switch, requires machine reset in case of power failure or circuit interruption.

Adjustable spindle tension re spring.

Built-in laser pointer.

Sturdy design with cast-iron head, base, and table.

High-quality bearings for smooth vibration-free operation.

Simple hand lever controlled mechanical variable speed from 500 to 3000 rpm.

Digital spindle speed display. 1/3 HP industrial-quality, 120 motor.

Equipped with easy to adjust dual depth stop for complete control of both down stroke depth and upstroke travel.

5/8" chuck with key & cover onboard chuck key holder.

Easy to use see-through flip-chuck guard included.

Crank-operated rack and pinion table height adjustment.



Optional accessories

22 piece drill set 1/16" to 3/8" (#70-020).

9" auger drill bit set (#70-105).

Chuck guard (#70-115A).

Self-centering pen drilling vise (#70-120).

Drill press tool tray (#70-125).

Chuck guard (#70-155).

Swing	12" (305 mm)
Drilling capacity Chuck size	5/8" (16 mm)
Spindle travel	5/8" (16 mm)
Spindle distance to table	3 1/8" (80 mm)
Spindle distance to base	15" (380 mm)
Table size	21 7/8" (556 mm)
Column diameter	9 1/2" x 9 1/2" (240 x 240 mm)
Spindle	2 1/2" (65 mm)
Overall height	(variable) 500 to 3000 rpm MT2
Base size	33" (840 mm)
Motor	15" x 9 5/8" (380 x 245 mm) 1/3 HP, 120 V, 3.1 A
Weight	75 lbs (34 kg)

General International**#75-060 | 15" variable speed drill press****Features**

Adjustable spindle tension return spring.

Built-in laser pointer.

Sturdy design with cast-iron head, base, and table.

High-quality bearings for smooth, vibration-free operation.

Simple hand lever controlled mechanical variable speed from 280 to 2100 rpm.

Digital spindle speed display.

Industrial-quality 120 V motor.

Chuck with key.

Easy to use see-through flip-up chuck guard included.

Crank-operated rack and pinion table height adjustment.

**Optional accessories**

22 piece drill set 1/16" to 3/8" (#70-020).

9" auger drill bit set (#70-105).

Chuck guard (#70-115A).

Self-centering pen drilling vise (#70-120).

Drill press tool tray (#70-125).

Chuck guard (#70-155).

Swing	15" (390 mm)
Drilling capacity	3/4" (20 mm)
Chuck size	5/8" (16 mm)
Spindle travel	3 1/8" (80 mm)
Spindle distance to table	17.1" (435 mm)
Spindle distance to base	26.8" (680 mm)
Table size (diameter)	12 3/8" (315 mm)
Column diameter	2 3/4" (70 mm)
Spindle speeds	(variable) 280 to 2100 rpm
Spindle	MT2
Overall height	41.9" (1065 mm)
Base size	17" x 10 1/2" (430 x 265 mm)
Motor	1/2 HP, 120 V, 5 A
Weight	128.7 lbs (58.5 kg)

Features

- Adjustable spindle tension return spring.
- Built-in laser pointer.
- Sturdy design with cast-iron head, base, and table.
- High-quality bearings for smooth, vibration-free operation.
- Simple hand lever controlled mechanical variable speed from 280 to 2100 rpm.
- Digital spindle speed display.
- Industrial-quality 120 V motor.
- Chuck with key.
- Easy to use see-through flip-up chuck guard included.
- Crank-operated rack and pinion table height adjustment.

#75-155 M1 | 15" variable speed drill press



Optional accessories

- 22 piece drill set 1/16" to 3/8" (#70-020).
- 9" auger drill bit set (#70-105).
- Chuck guard (#70-115A).
- Self-centering pen drilling vise (#70-120).
- Drill press tool tray (#70-125).
- Chuck guard (#70-155).

Chuck size	15" (390 mm)
Spindle travel	3/4" (20 mm)
Spindle distance to table	5/8" (16 mm)
Spindle distance to base	3 1/8" (80 mm)
Table size (diameter)	29 3/8" (745 mm)
Column diameter	48 1/2" (1230 mm)
Spindle speeds	12 3/8" (315 mm)
Spindle	2 3/4" (70 mm)
Overall height	(variable) 280 to 2100 rpm
Base size	MT2
Motor	63 3/8" (1610 mm)
Weight	17" x 10 1/2" (430 x 265 mm)
	1/2 HP, 120 V, 5 A
	136 lbs (62 kg)

Features

- Adjustable spindle tension return spring.
- Built-in laser pointer.
- Sturdy design with cast-iron head, base, and table.
- High-quality bearings for smooth, vibration-free operation.
- Simple hand lever controlled mechanical variable speed from 280 to 2100 rpm.
- Digital spindle speed display.
- Industrial-quality 120 V motor.
- Chuck with key.
- Easy to use see-through flip-up chuck guard.
- Crank-operated rack and pinion table height adjustment.



#75-165 | 17" variable speed drill press



Optional accessories

- 22 piece drill set 1/16" to 3/8" (#70-020).
- 9" auger drill bit set (#70-105).
- Chuck guard (#70-115A).
- Self-centering pen drilling vise (#70-120).
- Drill press tool tray (#70-125).
- Chuck guard (#70-155).

Swing	17" (430 mm)
Drilling capacity	1 1/8" (28 mm)
Chuck size	5/8" (16 mm)
Spindle travel	3 1/8" (80 mm)
Spindle distance to table	29 (735 mm)
Spindle distance to base	48 3/5" (1235 mm)
Table size (diameter)	13 1/4" x 13 1/4" (355 x 355 mm)
Column diameter	3 1/8" (80 mm)
Spindle speeds	(variable) 280 to 2100 rpm
Spindle	MT3
Overall height	64 3/8" (1635 mm)
Base size	20 1/4" x 12" (515 x 303 mm)
Motor	1 HP, 120 V, 6.5 A
Weight	161 lbs (73 kg)

General International | General / General International + Metalworking product

Features

Electronic inverter variable control adjusts spindle speed from 120 to 3200 rpm.

Front-mounted digital spindle speed display.

Adjustable spindle tension return spring.

Built-in laser pointer.

Sturdy design with cast-iron head, base, and table.

High-quality bearings for smooth, vibration-free operation.

1 HP industrial-quality, 220 V motor.

5/8" chuck with key.

Easy to use see-through flip-up chuck guard included.

Crank-operated rack and pinion table height adjustment.

#75-710 | 17" electronic variable speed drill press



Optional accessories

22 piece drill set 1/16" to 3/8" (#70-020).

9" auger drill bit set (#70-105).

Chuck guard (#70-115A).

Self-centering pen drilling vise (#70-120).

Drill press tool tray (#70-125).

Chuck guard (#70-155).

Swing	17" (430 mm)
Drilling capacity	1 1/8" (28 mm)
Chuck size	5/8" (16 mm)
Spindle travel	3 1/8" (80 mm)
Spindle distance to table	29" (735 mm)
Spindle distance to base	48 5/8" (1235 mm)
Table size	13 1/4" x 13 1/4" (335 x 335 mm)
Column diameter	3 1/8" (80 mm)
Spindle speeds (variable)	120 to 480 rpm 280 to 1200 rpm 740 to 3200 rpm
Spindle	MT3
Overall height	64 3/8" (1635 mm)
Base size	20 1/4" x 12" (515 x 303 mm)
Motor	1 HP, 220 V, 3 Ph
Input power	120 V single phase only
Weight	161 lbs (73 kg)

General International | General / General International + Metalworking product

Features

- Adjustable spindle tension return spring.
- Built-in laser pointer.
- Sturdy design with cast-iron head, base, and table.
- High-quality bearings for smooth, vibration-free operation.
- Simple hand lever controlled mechanical variable speed from 280 to 2100 rpm.
- Digital spindle speed display.
- Industrial-quality 120 V motor.
- Chuck with key.
- Easy to use see-through flip-up chuck guard included.
- Crank-operated rack and pinion table height adjustment.

#75-510 | 20" variable speed drill press



Optional accessories

- 22 piece drill set 1/16" to 3/8" (#70-020).
- 9" auger drill bit set (#70-105).
- Chuck guard (#70-115A).
- Self-centering pen drilling vise (#70-120).
- Drill press tool tray (#70-125).
- Chuck guard (#70-155).

Swing	20" (515 mm)
Drilling capacity	1 1/4" (32 mm)
Chuck size	3/4" (20 mm)
Spindle travel	4 3/4" (120 mm)
Spindle distance to table	27 3/4" (705 mm)
Spindle distance to base	46 7/8" (1190 mm)
Table size	18 3/4" x 16 3/4" (475 x 425 mm)
Column diameter	3 5/8" (92 mm)
Spindle speeds	(variable) 280 to 2100 rpm
Spindle	MT3
Overall height	67" (1700 mm)
Base size	23 5/8" x 15 3/4" (600 x 400 mm)
Motor	1 HP, 120 V, 10 A 284 lbs (129 kg)

General International

Features

#90-030 | 10" wood cutting bandsaw



Sturdy welded steel frame & precision-balanced wheels with replaceable tires.

Easy-to-assemble open-based steel stand.

Precision blade guide bearings included.

Miter gauge with auxiliary aluminum crosscut fence included.

Quick-release blade tension for fast blade changes.

Hinged doors and easily accessible blade tension knob, for fast blade changes and adjustments.

Large stable cast-iron table with slide-out steel extension wing.

Includes goose-neck style worklight.

Smooth running durable 1/3 HP motor.

Convenient blade tracking window.

Safety lock-out switch with removable key to prevent unauthorized use.

Multi-size dust port fits 4", 3", or 2" hose.

Wheel size	10" (254 mm)
Wheel speeds	1134 rpm
Blade speeds	2920 lin. fpm
Blade width	1/8" to 1/2" (3 to 12 mm)
Blade length	67 1/2" (1712 mm)
Table size	13 3/8" x 13 1/8" (340 x 335 mm)
Table tilt	0° to 45° (right)
Table height	42" (1067 mm)
Maximum width of cut	9 5/8" (245 mm)
Maximum depth of cut	4 1/16" (103 mm)
Dust outlet	2", 3" & 4" (51, 76 & 102 mm)
Base dimensions (l x w)	15 1/2" x 12 1/2" (395 x 310 mm)
Motor	1/3 HP, 120 V, 3.4 A
Weight	80 lbs (36 kg)

Features

#90-040 M1 | 12" wood cutting bandsaw

Sturdy welded steel frame & precision balanced wheels with replaceable tires.

Easy-to-assemble open-base steel stand.

Precision easy-adjust European style blade guide bearings included.

Two cutting speeds for excellent results in either hard or soft woods.

Miter gauge with aluminum crosscut fence included.

Deluxe dual-position rip fence system.

Hinged doors and easily accessible blade tension knob, for fast blade changes and adjustments.

Extra-large 21 1/2" x 15 3/4" cast-iron table.

Smooth running heavy-duty 2/3 HP motor.

Safety lock-out switch with removable key to prevent unauthorized use.

Multi-size dust port fits 4", 3", or 2" hose.



Optional accessories

N/A

Wheel size	12" (315 mm)
Wheel speeds (2)	445 & 970 rpm
Blade speeds (2)	1444 & 3150 lin. fpm
Blade width	1/8" to 3/4" (3 to 19 mm)
Blade length	88" (2240 mm)
Table size	21 1/2" x 15 3/4" (548 x 400 mm)
Table tilt	0° to 45° (right)
Table height	37 3/8" (950 mm)
Maximum width of cut	12" (305 mm)
Maximum depth of cut	6 1/2" (165 mm)
Dust outlet	2", 3" & 4" (51, 76 & 102 mm)
Base dimensions (l x w)	18 1/4" x 15 3/4" (465 x 400 mm)
Motor	2/3 HP, 120 V, 6.4 A
Weight	165 lbs (75 kg)

General International

Features

Sturdy welded steel frame & precision balanced wheels with replaceable tires.

Sturdy closed base steel stand. Deluxe blade guide bearings included.

Precision metal miter gauge.

Two cutting speeds for excellent results in either hard or soft woods.

Deluxe dual-position rip fence system.

Hinged doors and easily accessible blade tension knob, for fast blade changes and adjustments.

Extra-large 21 1/2" x 15 3/4" cast-iron table.

Smooth running heavy-duty 1 HP motor.

Safety lock-out switch with removable key to prevent unauthorized use.



#90-120 M1 | 14" wood cutting bandsaw

Wheel size	14" (350 mm)
Wheel speeds (2)	436 & 909 rpm
Blade speeds (2)	1575 & 3280 lin. fpm
Blade width	1/8" to 3/4" (3 to 19 mm)
Blade length	100 3/4" (2560 mm)
Table size	21 1/2" x 15 3/4" (548 x 400 mm)
Table tilt	0° to 45° (right)
Table height	39 3/8" (950 mm)
Maximum width of cut	13 3/8" (340 mm)
Maximum depth of cut	9" (230 mm)
Dust outlet	4" (102 mm)
Base dimensions (l x w)	22 7/8" x 17 3/8" (580 x 440 mm)
Motor	1 HP, 120 V, 9.5 A
Weight	194 lbs (88 kg)

Features

Heavy-duty massive router lift with 9 1/4" x 11 3/4" and aluminum top plate.

Stable four post/lift screw design & chain drive lifting system controlling all four corners simultaneously.

Fits all fixed base router motors*.

Smooth above-the-table adjustment mechanism for fast tool changes & precision bit setting.

Available with table in either cast-iron (40-200C), MDF (40-200M) or Phenolic (40-200P).

Stand made of tubular steel, includes, mobility kit, adjustable leveling feet and easy access on/off safety switch with removable lock-out key.

Fence has 2 1/4" dust collection outlet and adjustable scales.

Under table steel dust enclosure with access door, adjustable air vent, power cord grommet and 4" dust port with 2 1/4" branch inlet to the fence. Includes 2 1/4" dust hose and two hose clamps.

* Some router models may require reducer collars / adaptors.

#40-200 | Deluxe router table kit (Floor model)



Optional accessories

4 pc zero clearance insert ring set (#40-074).

4 pc insert ring set 1/4", 1/2", 2 1/2" & 1 3/8" (30 mm for #40-099) (#40-076).

Flip stop (#40-090).

Leveler bars for 9 1/4" x 11 3/4" plates or lifts (#40-092).

9 pcs brass precision template guide set (#40-099).

On/off switch for router table (#40-110).

Phenolic router insert plate (#40-114).

Aluminum router insert plate (#40-115).

Stock pusher (#40-120).

Vertical featherboard (#40-160).

Horizontal featherboard (#40-175).

Reducer collar (#40-312).

Reducer collar (#40-314).

Overall dimensions	35 1/2" X 24" X 41" (902 X 609 X 1041 mm)
Table size (l x w x h)	24" x 32" x 1 1/4" (609 x 812 x 32 mm)
Table height	36 1/2" (927 mm)
Fence size (each)	3" x 17 3/4" x 3/4" (76 x 451 x 19 mm)
Maximum fence travel	9" (229 mm)
Dust outlet	4" (102 mm)
Distance between t-slot & spindle center	3/4": 5 5/8" (143 mm) / 3/8": 7 3/16" (183 mm)
Distance from spindle center to front edge of table	12" (305 mm)
T-slot dimensions	3/4" x 3/8" (19 x 10 mm) / 3/8" x 1/4" (10 x 7 mm)
Router insert plate	9 1/4" x 11 3/4" (235 x 298 mm)
Table opening sizes (diameter)	(Plate) 3 3/4" (95 mm) / (Insert ring) 1 1/2" (38 mm)
Weight (shipping / net) - model 40-200C	185 lbs (84 kg) / 179 (81 kg)

Included accessories:

- Router fence (#40-080).
- Stand (#40-085).
- Router lift (#40-125).
- Dust collection kit (#40-130).

+ one of the following:

- Cast-iron table (#40-075) for 40-200C.

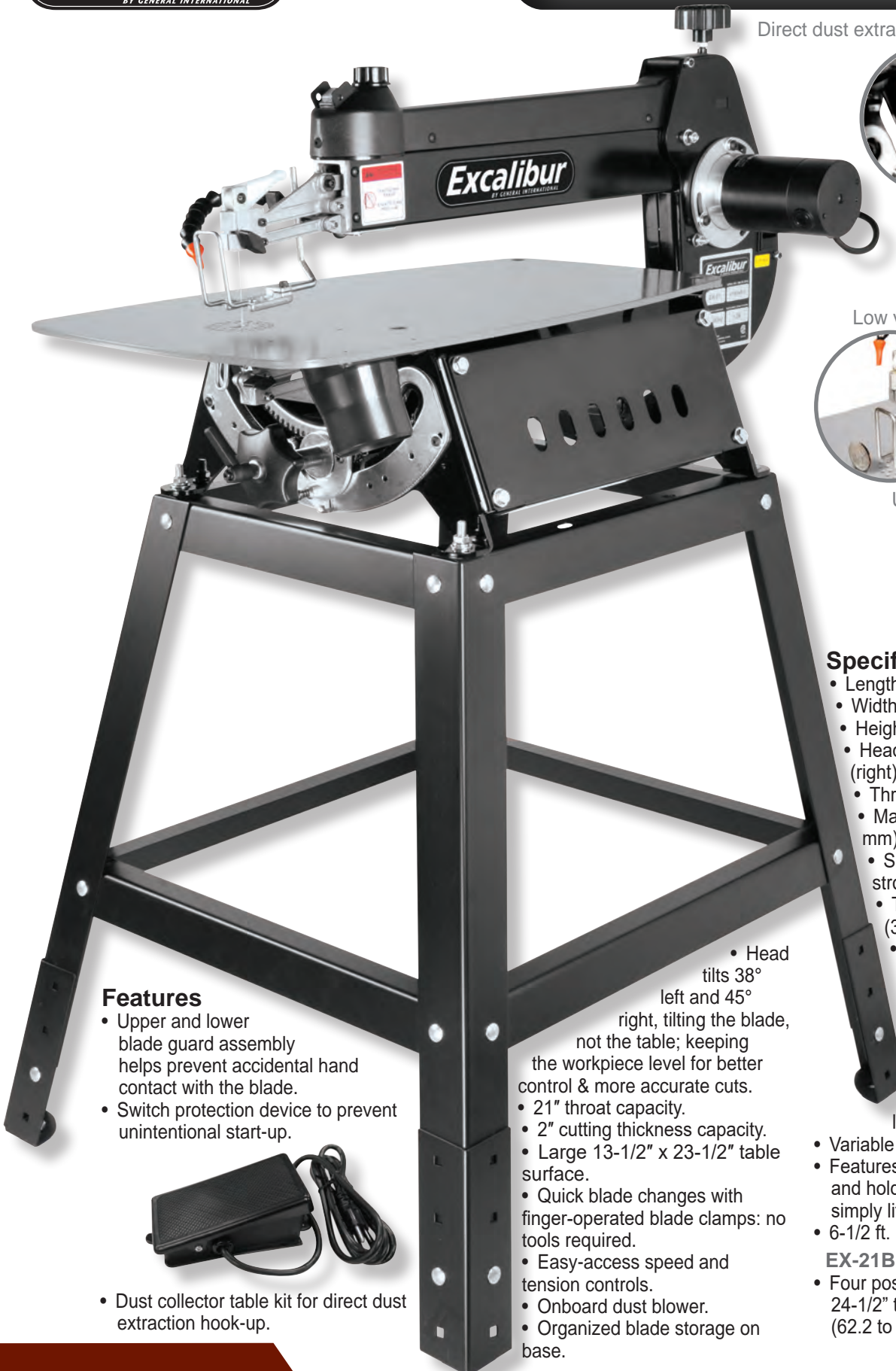

Direct dust extraction hook-up



Head tilts- not the table



Low vibration



Upper and lower blade guards



Features

- Upper and lower blade guard assembly helps prevent accidental hand contact with the blade.
- Switch protection device to prevent unintentional start-up.



- Dust collector table kit for direct dust extraction hook-up.

- Head tilts 38° left and 45° right, tilting the blade, not the table; keeping the workpiece level for better control & more accurate cuts.
- 21" throat capacity.
- 2" cutting thickness capacity.
- Large 13-1/2" x 23-1/2" table surface.
- Quick blade changes with finger-operated blade clamps: no tools required.
- Easy-access speed and tension controls.
- Onboard dust blower.
- Organized blade storage on base.

Specifications

- Length: 32" (812 mm)
- Width: 15" (380 mm)
- Height: 15" (380 mm)
- Head tilt range: 38° (left) to 45° (right)
- Throat capacity: 21" (535 mm)
- Maximum cutting depth: 2" (51 mm)
- Speed: (variable) 400 to 1550 strokes/min
- Table surface: 13-1/2" x 23-1/2" (345 x 597 mm)
- Motor: 120 V, 1.3 A

Kit consists of 1 each:

EX-21 Scroll Saw

EX-01 Foot switch

- Enjoy hands-free on/off control with scroll saws and other small 110V 15 amp (or less) tools.
- Variable speed
- Features constant "off" mode, press and hold down the switch to turn "on", simply lift foot from switch to turn "off".
- 6-1/2 ft. (2 m) 16 gauge power cord.

EX-21BS Adjustable metal stand

- Four positions from 24-1/2" to 31-1/2" high (62.2 to 80 cm high)



Direct dust extraction hook-up



Head tilts- not the table



Upper and lower blade guards



Low vibration

**Features**

- Upper and lower blade guard assembly helps prevent accidental hand contact with the blade.
- Switch protection device to prevent unintentional start-up.
- Dust collector table kit for direct dust extraction hook-up.
- Head tilts 38° left and 45° right, tilting the blade, not the table; keeping the workpiece level for better control & more accurate cuts.
- 21" throat capacity.
- 2" cutting thickness capacity.
- Large 13-1/2" x 23-1/2" table surface.
- Quick blade changes with finger-operated blade clamps: no tools required.
- Easy-access speed and tension controls.
- Onboard dust blower.
- Organized blade storage on base.

Specifications

- Length: 32" (812 mm)
- Width: 15" (380 mm)
- Height: 15" (380 mm)
- Head tilt range: 38° (left) to 45° (right)
- Throat capacity: 21" (535 mm)
- Maximum cutting depth: 2" (51 mm)
- Speed: (variable)
400 to 1550 strokes/min
- Table surface:
13-1/2" x 23-1/2" (345 x 597 mm)
- Motor: 120 V, 1.3 A

Includes:

- **EX-01 Foot switch**
- Enjoy hands-free on/off control with scroll saws and other small 110V 15 amp (or less) tools.
- Variable speed

- Features constant "off" mode, press and hold down the switch to turn "on", simply lift foot from switch to turn "off".
- 6-1/2 ft. (2 m) 16 gauge power cord.

Optional Accessories:**EX-21BS Adjustable metal stand**



Direct dust extraction hook-up



Head tilts- not the table



Low vibration



Upper and lower blade guards

**Specifications**

- Length: 27" (686 mm)
- Width: 15" (380 mm)
- Height: 17" (432 mm)
- Head tilt range: 30° (left) to 45° (right)
- Throat capacity: 16" (406 mm)
- Maximum cutting depth: 2" (51 mm)
- Speed: (variable) 400 to 1400 strokes/min
- Table surface: 12" x 18-1/2" (305 x 470 mm)
- Motor: 120 V, 1.3 A

Kit consists of 1 each:**EX-16 Scroll Saw****EX-01 Foot switch**

- Enjoy hands-free on/off control with scroll saws and other small 110V 15 amp (or less) tools.
- Variable speed
- Features constant "off" mode, press and hold down the switch to turn "on", simply lift foot from switch to turn "off".
- 6-1/2 ft. (2 m) 16 gauge power cord.

EX-21BS Adjustable metal stand

- Four positions from 24-1/2" to 31-1/2" high (62.2 to 80 cm high)

Features

- Upper and lower blade guard assembly helps prevent accidental hand contact with the blade.
- Switch protection device to prevent unintentional start-up.
- Dust collector table kit for direct dust extraction hook-up.
- Head tilts 30° left and 45° right, tilting the blade, not the table; keeping the workpiece level for better control & more accurate cuts.
- 16" throat capacity.
- 2" cutting thickness capacity.
- Large 12" x 18-1/2" table surface.
- Quick blade changes with finger-operated blade clamps: no tools required.
- Easy-access speed and tension controls.
- Onboard dust blower.

Direct dust extraction hook-up



Head tilts- not the table



Upper and lower blade guards



Easy blade changes



Low vibration



Features

- Upper and lower blade guard assembly helps prevent accidental hand contact with the blade.
- Switch protection device to prevent unintentional start-up.
- Dust collector table kit for direct dust extraction hook-up.
- Head tilts 30° left and 45° right, tilting the blade, not the table; keeping the workpiece level for better control & more accurate cuts.
- 16" throat capacity.
- 2" cutting thickness capacity.
- Large 12" x 18-1/2" table surface.
- Quick blade changes with finger-operated blade clamps: no tools required.
- Easy-access speed and tension controls.
- Onboard dust blower.

Specifications

- Length: 27" (686 mm)
- Width: 15" (380 mm)
- Height: 17" (432 mm)
- Head tilt range: 30° (left) to 45° (right)
- Throat capacity: 16" (406 mm)
- Maximum cutting depth: 2" (51 mm)
- Speed: (variable) 400 to 1400 strokes/min
- Table surface: 12" x 18-1/2" (305 x 470 mm)
- Motor: 120 V, 1.3 A

Optional Accessories

EX-01 Foot switch



EX-21BS Adjustable metal stand



16" X 24" CNC CARVING MACHINE

— MODEL EC-617 M1 —



Excalibur by General International with MASSO Controller

New!

EC-617 M1 Includes

- **New!** Renowned Excalibur By General International design expertise now available in CNC technology.
- Control Panel Steel enclosure Included.
Masso HTG5A15 upgradeable Controller includes Masso software. No computer needed! (Requires monitor and USB Keyboard).
- Smooth and accurate ball screw transmission on all axis.
- Powerful 550 watt variable frequency motor for excellent performance and low maintenance.
- Variable cutting up to 118 inches per minute.
- Spindle speeds up to 24,000 rpm with automatic spindle ON/OFF control.
- 1 year limited warranty
- Positional accuracy up to +/- 0.004 inches.
- Aluminum table with integrated hold down clamps.

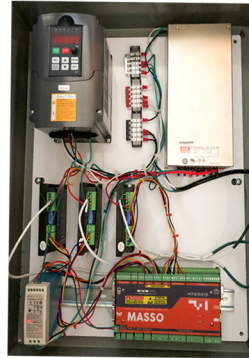

Accessories
(Sold Separately)

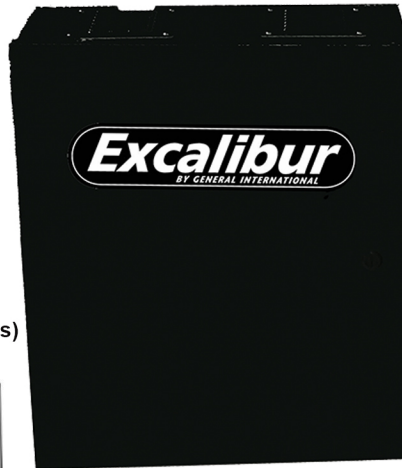

**EC-617X
Safety Enclosure**

*Optional
(ideal for educational users)



EC-617BSD

*Optional
Dust collector and stand



**40-928
8 pc.
CNC BitSet**

SPECIFICATIONS

X Axis Cutting Capacity	16" (406 mm)
Y Axis Cutting Capacity	24" (610 mm)
Z Axis Cutting Capacity	4" (102 mm)
Positional Accuracy	± 0.004" (± 102 mm)
Overall Dimensions (W x L x H) Machine Only	27-3/4" x 38-1/2" x 27-1/2" (704 x 980 x 700 mm)
Overall Dimensions (W x L x H) With Stand	40-1/8" x 31-1/2" x 55-1/8" (1020 x 800 x 1400 mm)
Overall Dimensions (W x L x H) With Stand & Enclosure	32-1/4" x 43-1/4" x 56-1/4" (820 x 1100 x 1430 mm)
Spindle Speed	0 - 24,000 tr/min
Spindle/ Motor Type	550 watts / variable frequency motor
Table Surface Material	Aluminium
Table Surface Size	38" X 22"
Programming Software Included	MASSO HTG5A15 Controller
Cutting Speeds	Variable – Up to 118" per minute
Input Power Requirements	110/115 V – 9 A
Collets (How Many & Sizes Included)	1 x 1/4" (6 mm)
Warranty	1 year – Limited
Weight (Shipping/Net)	308/264 lbs (140/120 kg)

12" wood turning lathe

Variable speed



Included accessories:

Spur center (#1632SA), live center (#2651-1), Knock out bar (#2644), 4" (#165) & 12" (#166) tool rest, 3" diameter face plate (#1637), tool rest carriage (#264SA).



16018-2



Mechanical variable speed

Note Specifications are Preliminary

Features

High quality ribbed cast-iron headstock, tailstock, and bed.

Precision-machined bed guideways allow the tailstock and tool rest to slide smoothly.

Precision-machined, high quality steel spindle, mounted on sealed, permanently lubricated bearings.

Equipped with plunger-type pin indexing mechanism for reeding and fluting.

Spindle nose is threaded $\frac{3}{8}$ " at both ends and bored for a "Morse No.2" taper.

Removable headstock cover for access to the spindle and indexing mechanism.

Powerful North American designed, totally enclosed, fan cooled industrial motor.

Push-button switch on single-phase units and a magnetic safety switch on all 3-phase units.

Increase or decrease speed without stopping the machine using the front mounted control lever.

Specifications

SWING-OVER BED CAPACITY
18" (457 mm)

SWING-OVER GAP CAPACITY
21" (533 mm)

MAXIMUM DISTANCE BETWEEN CENTERS
38" (965 mm)

FLOOR TO SPINDLE CENTER
41" (1041 mm)

**NOSE-INBOARD & NOSE-OUTBOARD
(right-hand threads or left-hand threads)**
1" (25.4 mm) - 8 tpi

SPINDLE BORE
 $\frac{3}{8}$ " (16 mm)

HEADSTOCK & TAILSTOCK TAPER
MT #2

TAILSTOCK SPINDLE TRAVEL
2" (50.8 mm)

**SPINDLE SPEEDS
(variable)** 500 to 3000 rpm -

MOTOR
M1 1 HP, 115 V, 1 Ph, 12.8 A



10" 3 HP deluxe cabinet saw

350 M1 / 650 M1



Quick release combination riving style splitter and blade guard with anti-kickback pawls and a second European style riving knife also included.

Note Specifications are Preliminary

Features

- Powder coated, scratch resistant, high quality reinforced steel cabinet.
- Large, heavy-duty cast-iron handwheels for effortless blade adjustments.
- High-precision General "T" Fence System with 50" long guide rails, a melamine extension table and adjustable support legs ("Millenium Edition only").
- 2 miter gauge T-slots and deluxe cast-iron miter gauge.
- Magnetic 2-step safety switch to prevent unwanted or unintentional start-up is equipped with an extra-large easy access stop panel and a lock-out key to prevent unauthorized use of the saw.
- Powerful made in USA, totally enclosed, fan cooled industrial motor.
- Matching dual V-belt drive, on balanced cast-iron pulleys for smooth vibration-free running.
- Arbor mounted on heavy-duty, permanently lubricated, sealed ball-bearings.

Spécifications

- BLADE DIAMETER**
10" (254 mm)
- ARBOR DIAMETER**
 $\frac{5}{8}$ " (16 mm)
- ARBOR TILTING RANGE**
0° to 45°
- ARBOR SPEED**
4000 rpm
- MAXIMUM DEPTH OF CUT AT 90°**
3 $\frac{1}{8}$ " (79 mm)
- MAXIMUM DEPTH OF CUT AT 45°**
2 $\frac{1}{8}$ " (54 mm)
- MAXIMUM RIP TO LEFT OF BLADE**
12" (305 mm)
- MAXIMUM RIP TO RIGHT OF BLADE**
50" (1270 mm)
- MAXIMUM DADO WIDTH**
 $\frac{13}{16}$ " (21 mm)
- DISTANCE AHEAD OF BLADE**
12 $\frac{3}{4}$ " (324 mm)
- TABLE SIZE**
28" x 36" (711 x 914 mm)
- TABLE HEIGHT**
34" (864 mm)
- SIZE OF T-SLOTS**
 $\frac{3}{8}$ " x $\frac{3}{4}$ " (10 x 19 mm)
- MOTOR**
M1 3HP 230V

WEIGHT (shipping / net)
539 lbs (245 kg) / 495 lbs (225 kg)

#50-025 | Universal mobile base









- 2 heavy-duty 3" wheels.
- 2 heavy-duty 2 1/2" casters.
- 2 rubber levelling feet.
- Adjustment in 1" increments.
- Load capacity: 500 lbs (227 kg).

Minimum square size	11" x 11" (279 x 279 mm)
Maximum square size	35 1/4" x 35 1/4" (894 x 894 mm)
Minimum rectangular size	17" x 11" (434 x 279 mm)
Maximum rectangular size	51" x 19" (1295 x 483 mm)

New Industrial Bench Grinder Series

Model #	Description	Images	Specifications
15-650	6" Bench Grinder		<ul style="list-style-type: none"> - Voltage: 120 V - Power: 1/3 HP - RPM: 3400 rpm - Wheel Size: 150 x 20 x 12.7 mm (6" x 3/4" x 1/2") - Arbor/shaft sizes:1/2" (12.7mm) - TPI (Threads per inch):1/2"-13UNC - Frequency 60 Hz -Grit(left/right):36/80 --Wheel Stonel(left/right): Grey - Weight :10kg
15-670	6" Bench Grinder		<ul style="list-style-type: none"> - Tension: 120V - Power 1/3 HP - RPM: 1750 rpm - Wheel Size: 150 x 40(left)/20(right) x 12.7 mm (6" x 1 1/2"(L)/3/4"(R) x 1/2") - Arbor/shaft sizes:1/2" (12.7mm) - TPI (Threads per inch):1/2"-13UNC - Frequency: 60 Hz -Grit(left/right):100/80 -Wheel Stonel(left/right):White + Brown - Weight :11kg
15-850	8" Bench Grinder		<ul style="list-style-type: none"> - Tension: 120 V - Power: 1/2HP - RPM: 3400 rpm - Wheel Size 200 x 25 x 15.875 mm (8" x 1" x 5/8") -shaft/arbor sizes : 5/8" (15.875mm) --TPI (Threads per inch): 5/8"-11UNC - Frequency: 60 Hz -Grit(left/right):36/80 -Wheel Stonel(left/right): Grey - Weight :16kg
15-870	8" Bench Grinder		<ul style="list-style-type: none"> - Tension: 120 V - Power: 1/2HP - RPM: 1750 rpm - Wheel Size 200 x 40/25 x 15 mm (8" x 1 1/2" (L) / 1"(R) x 5/8") -shaft/arbor sizes : 5/8" (15.875mm) --TPI (Threads per inch): 5/8"-11UNC - Frequency: 60 Hz -Grit(left/right):100/80 -Wheel Stonel(left/right):White + Brown - Weight :16kg
15-855	tire grinding / grinding machine		<ul style="list-style-type: none"> - Tension:120 V - Power: 1/2HP - RPM: 1750 rpm - Wheel Size: 200 x 25 x 15.875 (8" x 1" x 5/8") -Wheel Stonel(right): Brown - Frequency: 60 Hz

Model #	Description	Images	Specifications
	6" DoublePolishing Machines		Voltage: 120V 60HZ Power: 1/3HP Speed: 1750 rpm Polishing wheel: 150*20*10mm
	8" DoublePolishing Machines		Voltage: 120V 60HZ Power: 1/2HP Speed: 1750 rpm Polishing wheel: 200*20*10mm
New Industrial Bench Grinder Accessories			
Wheel Stonel: Brown(棕刚玉低温烧结)	Accessory :Grinding wheel		6" : Φ150*20*12.7mm , Grit 36 (6" x 3/4" x 1/2")
			6" : Φ150*20*12.7mm , Grit 80 (6" x 3/4" x 1/2")
			8" : Φ200*25*15.875mm, Grit 36 (8" x 1" x 5/8")
			8" : Φ200*25*15.875mm, Grit 80 (8" x 1" x 5/8")
Wheel Stonel: Sillicium carbide, Grit 120 for hard metal	Accessory :Grinding wheel		6" : Φ150*20*12.7mm , Grit 120 (6" x 3/4" x 1/2")
			8" : Φ200*25*15.875mm, Grit 120 (8" x 1" x 5/8")
Wheel Stonel: Aluminium oxide(白刚玉)	Accessory :Grinding wheel		6" : Φ150*20*12.7mm , Grit 60 (6" x 3/4" x 1/2")
			6" : Φ150*20*12.7mm , Grit 100 (6" x 3/4" x 1/2")
			8" : Φ200*25*15.875mm, Grit 60 (8" x 1" x 5/8")
			8" : Φ200*25*15.875mm, Grit 100 (8" x 1" x 5/8")
Cup Grinding Wheel Aluminium	Accessory :Grinding wheel		6" : Φ150*40*12.7mm , Grit 60 (6" x 1 1/2" x 1/2")
			6" : Φ150*40*12.7mm , Grit 100 (6" x 1 1/2" x 1/2")

Model #	Description	Images	Specifications
oxide (杯状白刚玉)			8" : $\Phi 200 \times 40 \times 15.875$ mm, Grit 60 8" x 1 1/2" x 5/8"
			8" : $\Phi 200 \times 40 \times 15.875$ mm, Grit 100 8" x 1 1/2" x 5/8"
支架	Accessory :Stand		
	Accessory : Steel wire brush		1. 6" : $\Phi 150 \times 18 \times 12.7$ mm ; 2. 8" : $\Phi 200 \times 18 \times 15.875$ mm
亚麻布	Accessory Polishing mop linen:		1. 6" : $\Phi 150 \times 18 \times 15$ mm ; 2. 8" : $\Phi 200 \times 18 \times 15$ mm :
	Accessory 1:Conical spindle on shaft-end		1. 6" : $\Phi 150 \times 18 \times 15$ mm ; 2. 8" : $\Phi 200 \times 18 \times 15$ mm
法兰绒	Accessory 3 Polishing mop flannel:		1. 6" : $\Phi 150 \times 18 \times 15$ mm ; 2. 8" : $\Phi 200 \times 18 \times 15$ mm :
	Accessory 4: Belt		Belt 1000*50mm, Grit 40, for BSS 8200



Contact Us: PH: 844-877-5234 ext 109
EM: info@gipowerproducts.com

