

**990 Series**

Canister Vacuum Cleaner. Household Type.

# Owner's Guide

*Thank you for purchasing your new Eureka vacuum!*

## Important instructions

For easy assembly, please take a few moments to read this owner's guide.

If you have questions about your new vacuum, please contact our customer service helpline at **1-800-282-2886**. *We're here to help!*

8 a.m. to 7:30 p.m. (CST), Monday - Friday

10 a.m. to 6:30 p.m. (CST), Saturday - Sunday

Promotional code: **eurekaad14**

Special Offer – receive 15% off parts and accessories when ordering online. Promotion excludes vacuums and maintenance packs.

---

## Guía del Propietario

*¡Gracias por la compra de su nueva aspiradora Eureka!*

Si tiene alguna pregunta sobre su nueva aspiradora, por favor contacte a nuestra línea de ayuda de atención al cliente llamando al **1-800-282-2886**. *¡Estamos aquí para ayudarle!*

8 a.m. a 7:30 p.m. (CST), de lunes a viernes

10 a.m. a 6:30 p.m. (CST), sábado y domingo

Código de promoción: **eurekaad14**

Oferta especial – reciba un 15% de descuento en piezas y accesorios cuando haga su pedido en línea. Esta promoción no incluye aspiradoras ni paquetes de mantenimiento.

---

## Le Guide du Propriétaire

*Merci d'avoir acheté votre nouvel aspirateur Eureka!*

Si vous avez des questions au sujet de votre nouvel aspirateur, veuillez contacter notre Ligne d'aide du Service à la clientèle au **1-800-282-2886**. *Nous sommes là pour vous aider!*

8 h à 19 h 30 (CST), lundi au vendredi

10 h à 18 h 30 (CST), samedi et dimanche

Code de promotion : **eurekaad14**

Offre spéciale – recevez 15% de réduction sur les pièces et les accessoires lorsque vous commandez en ligne. La promotion exclut les aspirateurs et les trousseaux d'entretien.



**www.eureka.com**

© 2012 Electrolux Home Care Products, Inc. Printed in China. PN85775

**eureka!**<sup>®</sup>  
Invented for the way you clean™

# Where to find important vacuum information

## Keep this information

Write the model, type and serial number here:

Date of purchase (keep your receipt) \_\_\_\_\_

Model number and type \_\_\_\_\_

Serial number \_\_\_\_\_

Find these numbers on a label on the underside of the vacuum cleaner. Refer to these numbers when ordering parts and accessories or if service is needed.



## Before you start your vacuum cleaner

Read these instructions for assembly and use. This owner's guide provides important instructions to prolong the life of your Eureka vacuum cleaner.

### Inspection

Carefully unpack and inspect your new Eureka vacuum cleaner for shipping damage. Each unit is tested and thoroughly inspected before shipping. For instructions regarding any shipping damage, call Eureka Customer Service **HELPLINE 1-800-282-2886** immediately.

### Table of contents

<b>Important safeguards</b> .....	1
<b>Thermal cut-off</b> .....	1
<b>What's in the carton</b> .....	2
<b>Easy assembly</b> .....	2
<b>How to identify parts of vacuum cleaner</b> .....	3
<b>Dust cup maintenance</b> .....	3
<b>Filter maintenance</b> .....	4
<b>How to use vacuum and accessories</b> .....	5
Automatic cord rewind, telescoping wand, crevice tool, and dusting brush.	
<b>How to clear a blockage</b> .....	5
<b>Problem solving</b> .....	6
<b>Eureka limited warranty information</b> .....	6
<b>Spanish owners guide</b> .....	7-13
<b>French owners guide</b> .....	14-20
<b>Order forms and parts list</b> .....	21-22



Follow caution information wherever you see this symbol.

# IMPORTANT SAFEGUARDS

When using an electrical appliance, basic precautions should always be followed, including the following:

## READ ALL INSTRUCTIONS BEFORE USING THIS VACUUM CLEANER WARNING

To reduce the risk of fire, electric shock, or injury:



- Do not use outdoors or on wet surfaces.
- **Do not leave vacuum cleaner when plugged in.** Turn off the switch and unplug the electrical cord when not in use and before servicing.
- Do not allow to be used as a toy. Close attention is necessary when used by or near children.
- Use only as described in this manual. Use only manufacturer's recommended attachments.
- Do not use with damaged cord or plug. If vacuum cleaner is not working as it should, has been dropped, damaged, left outdoors, or dropped into water, return it to a service center before using.
- Do not pull or carry by cord. Do not use cord as a handle. Do not close a door on cord or pull cord around sharp edges or corners. Do not run vacuum cleaner over cord. Keep cord away from heated surfaces.
- Hold plug when rewinding onto cord reel. Do not allow plug to whip when rewinding.
- Do not use extension cords or outlets with inadequate current carrying capacity.
- Turn off all controls before unplugging.
- Do not unplug by pulling on cord. To unplug, grasp the plug, not the cord.
- Do not handle plug or vacuum cleaner with wet hands.
- Do not put any object into openings. Do not use with any opening blocked; keep free of dust, lint, hair, and anything that may reduce airflow.
- This vacuum cleaner creates suction. Keep hair, loose clothing, fingers, and all parts of body away from openings and moving parts.
- Use extra care when cleaning stairs.
- Do not pick up anything that is burning or smoking, such as cigarettes, matches, or hot ashes.
- Do not use without dust cup and filter in place.
- Do not use to pick up flammable or combustible liquids such as gasoline, or use in areas where they may be present.
- Store your vacuum cleaner indoors in a cool, dry area.
- Keep your work area well lighted.
- Unplug electrical appliances before vacuuming them.
- Unplug before connecting stair and upholstery brush.

## SAVE THESE INSTRUCTIONS

**To reduce the risk of electric shock**, this appliance has a polarized plug (one blade is wider than the other). This plug will fit in a polarized outlet only one way. If the plug does not fit fully into the outlet, reverse the plug. If it still does not fit, contact a qualified electrician to install the proper outlet. Do not change the plug in any way.



**Motor: Do Not Oil** the motor or the brush roll at any time. The bearings are permanently lubricated and sealed.

**Thermal cut-off:** This vacuum cleaner has a special thermostat that protects the vacuum in case of motor overheating. If the vacuum suddenly shuts off, turn off the power switch and unplug the vacuum. Check the vacuum for a possible source of overheating such as a full dust cup, blocked hose or clogged filter. If these conditions are found, fix them and wait at least 30 minutes before attempting to use the vacuum. After the 30 minute period, plug the vacuum back in and turn on the switch. If the vacuum still does not work, take it to a Eureka authorized service center for repair or call 1-800-282-2886.

# What's in the carton

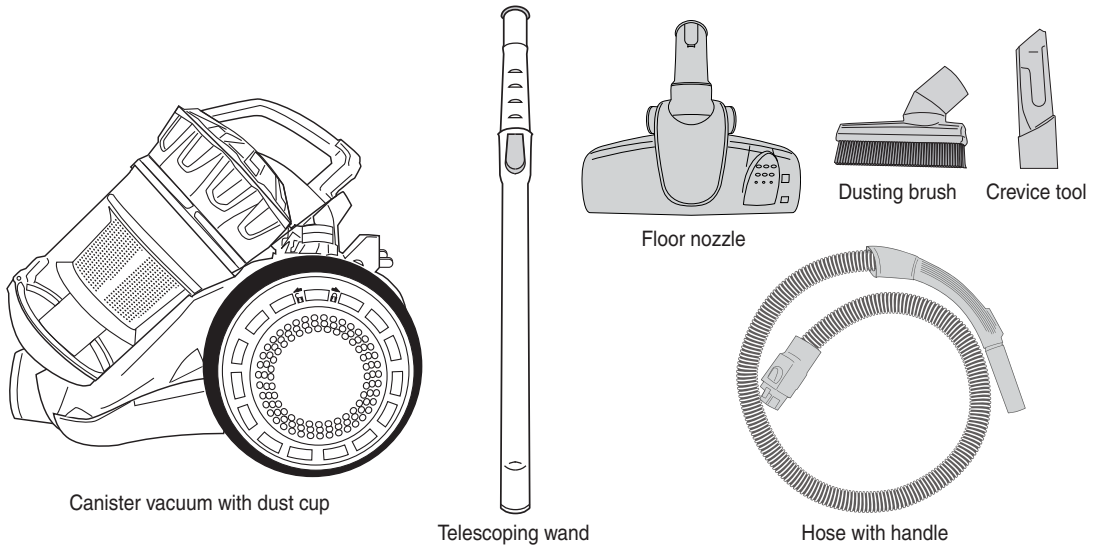

## Easy assembly

**!** Please read all instructions before using this vacuum cleaner. Moving parts!  
Assemble the vacuum cleaner before using.

### Hose with handle

- Insert hose into suction inlet; push in until it clicks (Fig. 1).
- Push hose handle into wand, aligning hose suction control and wand release button (Fig. 2).
- Push wand into floor nozzle; twist to tighten (Fig. 3).
- To store: Slip floor nozzle tab into slot on back of vacuum (Fig. 4).

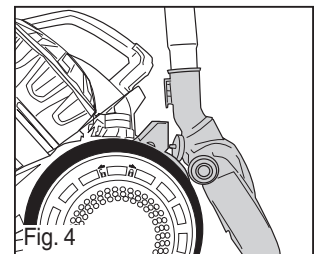
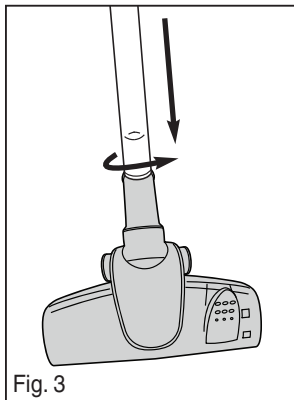
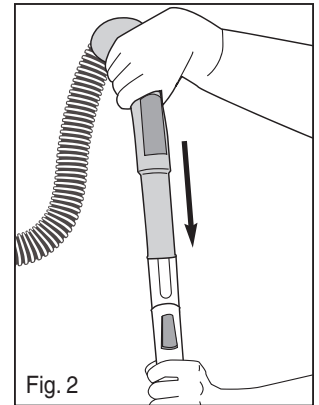
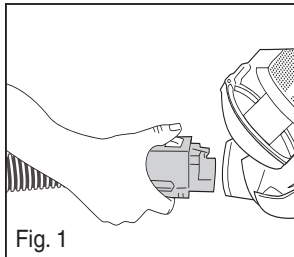

# How to identify parts of vacuum cleaner

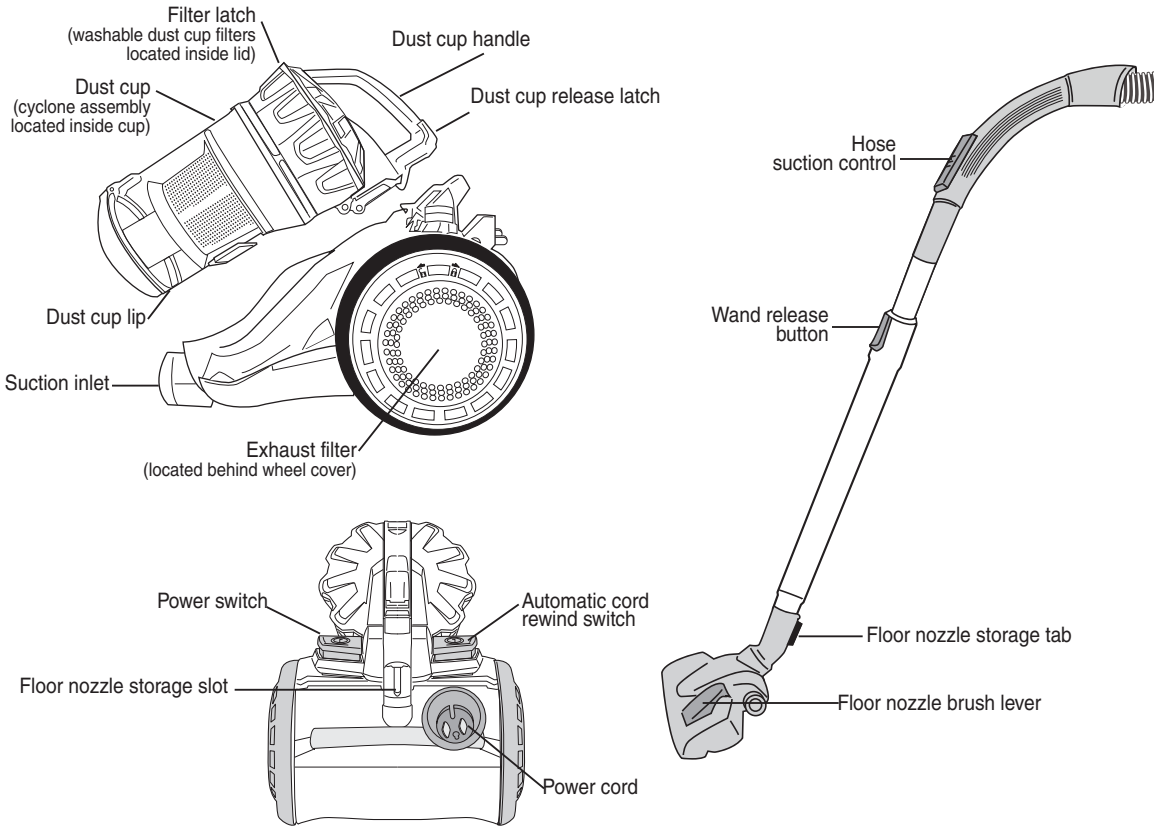

ENGLISH

## Dust cup maintenance

**!** Empty dust cup when debris reaches maximum fill line. Always empty after each use.

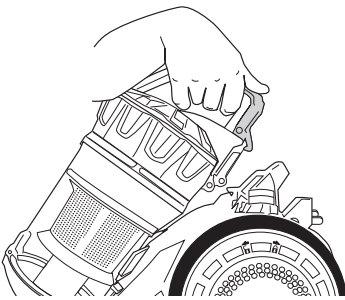

Press release latch and lift off dust cup.

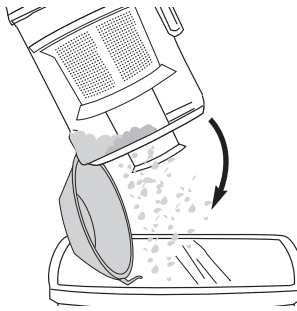

Hold over wastebasket and press down dust cup lever. Debris will empty.

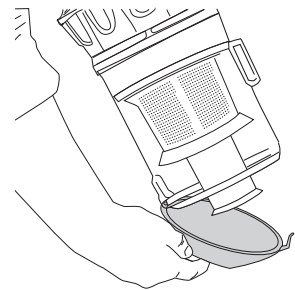

Close bottom lid until it clicks. Replace dust cup on canister.

# Filter maintenance

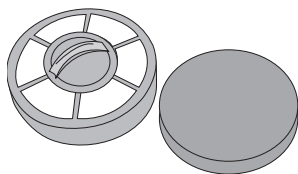

Washable dust cup filters 86051

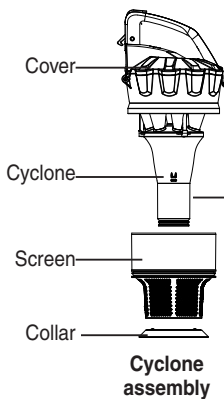

Cyclone assembly

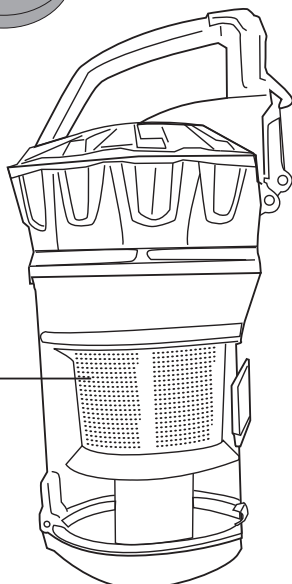

Dust cup

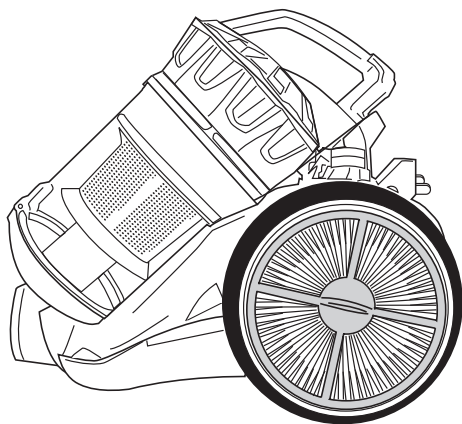

Exhaust filter 86015  
(located behind wheel cover)

## Clean as needed to maintain suction

### Wash screen

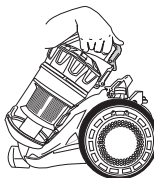

Press release latch and lift off dust cup.

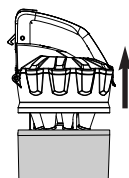

Twist to unlock cyclone assembly from cup.

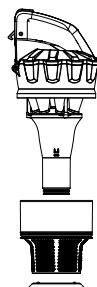

Twist and remove collar to release screen from cyclone.



Rinse screen and dry **THOROUGHLY**; reassemble.

### Washable filters 86051

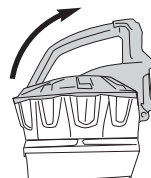

Lift filter latch to open cover.

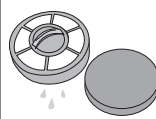

Remove foam filter from frame. Shake off dust. Rinse and dry **THOROUGHLY**.

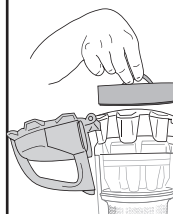

Reinstall filters.

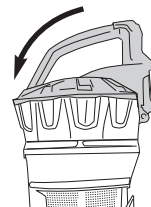

Close cover until it clicks.

## Replace within 6 months

### Exhaust filter 86015

#### Not washable

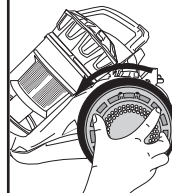

Grasp wheel cover and twist to left to unlock. Pull wheel cover straight out.

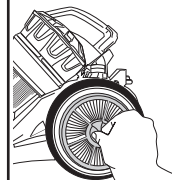

Pull out old exhaust filter.

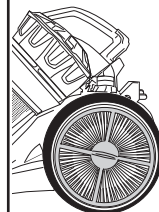

Place new filter inside wheel.

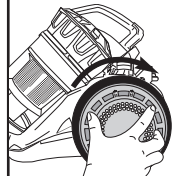

Reposition wheel cover over filter, twist to right to lock.

**Never use vacuum without all filters in place.**

# How to use vacuum and accessories



**Never use vacuum without all filters in place.**

**Empty dust cup after each use.**

**Make sure vacuum is turned off before connecting or disconnecting hose, telescoping wand, or tool.**

When pulling out power cord, watch for a yellow line on cord. Continue pulling cord slowly; stop pulling when you see the **red line!** The red line indicates the end of usable cord.

- Pull out cord to desired length (Fig. 1) and plug into electrical outlet.
- Adjust floor nozzle brush lever. For hard floors, press lever down to extend brushes (Fig. 2). For carpeted floors, pull lever up to retract brushes.
- Step on power switch to turn on vacuum (Fig. 3).
- To lengthen wand, push wand release button and pull to extend telescoping wand (Fig. 4).
- For accessories, push tool onto end of wand or directly onto hose handle; twist to tighten (Fig. 5).
- When vacuuming delicate surfaces such as drapes or picture frames, slide hose suction control to reduce suction (Fig. 6).
- When finished vacuuming, step on cord rewind switch to retract cord. Guide the cord with hand to be sure it does not whip around and cause damage.

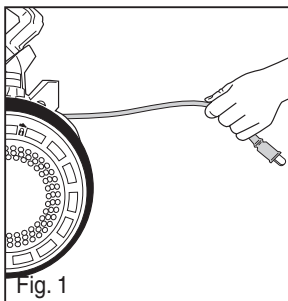

Fig. 1

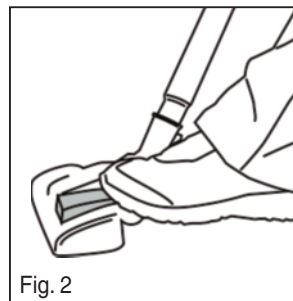

Fig. 2

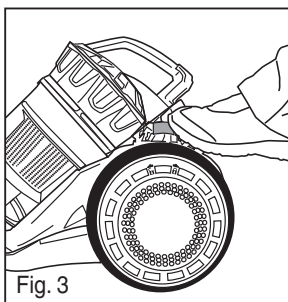

Fig. 3

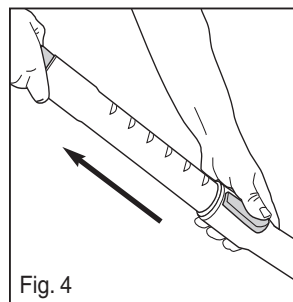

Fig. 4

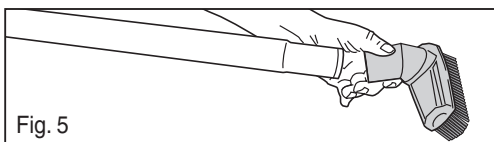

Fig. 5

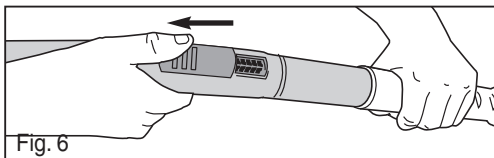
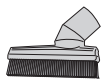

Fig. 6



## Crevice tool

Use for baseboards, corners and furniture. Push crevice tool onto end of wand.



## Dusting brush

Use for furniture, drapes and vents. Push dusting brush onto end of wand (Fig. 5).

## How to clear a blockage

**Make sure vacuum is turned off.**

**Watch for sharp objects.**

- Pull floor nozzle off wand and check for blockage (Fig. 7).
- Flex hose to clear any blockage (Fig. 8).

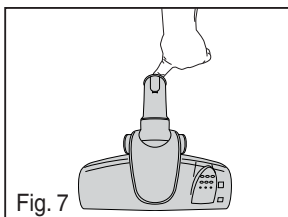

Fig. 7

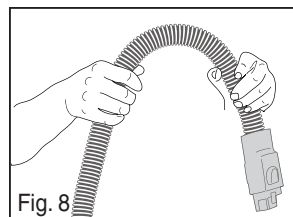

Fig. 8



# Problem solving

**Make sure vacuum is turned off and power cord is unplugged.**

Problem	Cause	Solution
<b>Motor will not start.</b>	Power switch	• Push power switch to turn vacuum on.
	Thermal cut-off	• See detailed thermal cut-off instructions on page 1.
<b>Vacuum does not clean carpet or bare floor.</b>	Dust cup and filter	<ul style="list-style-type: none"> <li>• Empty dust cup, clean and/or change filter.</li> <li>• If picking up fine dust, the dust cup may not look full, but a fine substance tends to reduce suction when it blocks air flow through the filter and screen. Refer to page 4 for filter maintenance. Make sure filter, screen and dust cup are installed properly.</li> <li>• Filter and screen must be in place for cover to lock.</li> </ul>
	Hose/wand assembly	<ul style="list-style-type: none"> <li>• Remove clogs from the hose and wand that restrict airflow. Page 5</li> <li>• Clear blockage from hose/wand assembly. Page 5</li> </ul>
<b>No suction at the end of wand.</b>	Dust cup and filter	<ul style="list-style-type: none"> <li>• Empty dust cup, clean and/or change filter.</li> <li>• If picking up fine dust, the dust cup may not look full, but a fine substance tends to reduce suction when it blocks air flow through the filter and screen. Refer to page 4 for filter maintenance. Make sure filter, screen and dust cup are installed properly.</li> <li>• Filter and screen must be in place for cover to lock.</li> </ul>
	Hose/wand assembly	<ul style="list-style-type: none"> <li>• Remove clogs from the hose and wand that restrict airflow. Page 5</li> <li>• Clear blockage from hose/wand assembly. Page 5</li> </ul>
	Floor Nozzle	• Check for blockage in nozzle. Page 5
<b>Cord will not rewind fully.</b>	Cord tangles	• Pull cord out and rewind. Page 5

## The Eureka limited warranty

Eureka warrants this vacuum cleaner to be free from defects in material and workmanship for a term of one year for normal household use. Warranty is granted only to the original purchaser and members of immediate household. This warranty is good for one year from the date of purchase only when the vacuum cleaner is used in the accordance with Eureka operating instructions.

### This warranty does not cover

- Parts of the vacuum that require replacement under normal use such as disposable dust bags, filters, drive belts, light bulbs, brush roll, bristles, impellers and cleaning.
- Damages or malfunctions caused by negligence, abuse, and use not in accordance with the Owner's Guide.
- Defects or damages caused by unauthorized service or the use of other than Genuine Eureka, ARM & HAMMER™ and Filtrite™ by 3M parts.

### What Eureka will do

Eureka will, at its option, repair or replace a defective vacuum or vacuum part that is covered by this warranty. As a matter of warranty policy, **Eureka will not refund the consumer's purchase price.**

### Warranty registration

Please fill out and return the warranty registration card accompanying your vacuum.

### Obtaining warranty service

To obtain warranty service you must return the vacuum or vacuum part along with "proof of purchase" to any Eureka Authorized Warranty Station. For Eureka Authorized Warranty Station or Service Information, visit [www.eureka.com](http://www.eureka.com), write or telephone toll free:

**USA: 1-800-282-2886**  
Electrolux Home Care  
North America Service Division  
P.O. Box 3900  
Peoria, IL 61612

**Mexico: (55) 5343-4384**  
Electrolux Home Care

**Canada: 1-800-282-2886**  
Electrolux Home Care  
North America Service Division  
5855 Terry Fox Way  
Mississauga, Ontario L5V 3E4

### Obtaining warranty service outside your community

You must pay the shipping charges to the Eureka Authorized Warranty Station. **Return Shipping Charges** will be paid by the Warranty Station. When returning parts for repair, please include the model, type and serial number located on the rating plate on the lower backside of the vacuum.

### Further limitations and exclusions

Any warranty that may be implied in connection with your purchase or use of the vacuum, including any warranty of Merchantability or any warranty for Fitness For A Particular Purpose is limited to the duration of this warranty. Some states do not allow limitations on how long an implied warranty lasts, so the above limitations may not apply to you. Your relief for the breach of this warranty is limited to the relief expressly provided above. In no event shall the manufacturer be liable for any consequential or incidental damages you may incur in connection with your purchase or use of the vacuum. Some states do not allow the exclusion or limitation of incidental or consequential damages, so the above limitation or exclusion may not apply to you. This warranty gives you specific legal rights. You may also have other rights, which may vary by state.

The ARM & HAMMER name is a trademark of Church and Dwight Co., Inc. 3M and Filtrite are trademarks of 3M Company, used by Electrolux Home Care Products, Inc. under license.