



# ***Shark***<sup>®</sup>

---

SK460

---

**OWNER'S GUIDE**

---



[WWW.SHARKCLEAN.COM](http://WWW.SHARKCLEAN.COM)



# IMPORTANT SAFETY INSTRUCTIONS

## For Household Use Only

WHEN USING YOUR *SHARK*<sup>®</sup> PROFESSIONAL STEAM & SPRAY<sup>™</sup> MOP, BASIC SAFETY PRECAUTIONS SHOULD ALWAYS BE FOLLOWED, INCLUDING THE FOLLOWING:

READ ALL INSTRUCTIONS BEFORE USING YOUR *SHARK*<sup>®</sup> PROFESSIONAL STEAM & SPRAY<sup>™</sup> MOP.



### DANGER OF SCALDING.

Please use caution when using the steam mop. The steam emitted from the steam mop is very hot.

### POLARIZED PLUG:

This appliance has a polarized plug (one blade is wider than the other). As a safety feature, this plug will fit into a polarized outlet only one way. If the plug does not fit fully into the outlet, reverse the plug. If it still does not fit, contact a qualified electrician. **Do not attempt to defeat this safety feature.**



### CAUTION:

Keep all *Shark*<sup>®</sup> branded cleaners out of the reach of children.

Eye irritant. Should some of the *Shark*<sup>®</sup> branded cleaners be rubbed or splashed into the eyes, wash out thoroughly with water. If irritation continues, contact a physician.

In case of ingestion, drink 16 FL. oz. (2 cups) of water.

## WARNING:

TO REDUCE THE RISK OF FIRE, ELECTRIC SHOCK OR INJURY:

1. Use **ONLY** with power supply cord provided with the appliance.
2. Use the system only for its intended use.
3. **DO NOT** use outdoors.
4. **DO NOT** leave the appliance unattended when plugged in. Always unplug the power cord from the electrical outlet when not in use and before servicing.
5. **CAUTION - Shock Hazard.** To provide continued protection against shock, disconnect from power supply when not in use.
6. Turn off all controls before unplugging.
7. **DO NOT** allow to be used as a toy. Close attention is necessary when used by or near children, pets or plants.
8. Use only as described in this manual.
9. Use only manufacturer's recommended accessories.
10. **DO NOT** use with damaged cord or plug. If the appliance is not working as it should, has been dropped, damaged, left outdoors, or dropped into water, return the appliance to EURO-PRO Operating LLC for examination and repair. Incorrect re-assembly or repair can cause a risk of electrical shock or injury to persons when the appliance is used.
11. To protect against a risk of electric shock, **DO NOT** immerse the appliance into water or any other liquids.
12. **DO NOT** handle the plug or the appliance with wet hands or operate the appliance without shoes.
13. **DO NOT** pull or carry by cord, use the power cord as a handle, close a door on the cord, or pull the cord around sharp edges or corners. Do not run the appliance over the power cord. Keep the power cord away from heated surfaces.



TOLL FREE: 1-800-798-7398



14. **DO NOT** unplug by pulling on the power cord. To unplug, grasp the plug not the power cord. Do not use extension cords or outlets with inadequate current carrying capacity.
15. **DO NOT** use for space heating purposes.
16. **DO NOT** put any objects into openings. Do not use with any opening that is blocked.
17. **DO NOT** put hands or feet under the **Shark®** Professional Steam & Spray™ Mop.
18. Keep hair, loose clothing, fingers, and all parts of the body away from openings and moving parts.
19. Use **ONLY** on flat, horizontal surfaces. Do not use on walls, counters or windows.
20. To reduce the risk of fire and electric shock - use **ONLY Shark®** cleaning solutions intended for use with this appliance.
21. **DO NOT** add any cleaning solutions in the **Shark®** Professional Steam & Spray™ Mop other than **Shark®** Steam Energized™ Cleanser. Use of other scented perfumes, oils or any other chemicals may damage or clog the unit and void the warranty.
22. **DO NOT** mix other cleaners with **Shark®** Steam Energized™ Cleanser as this could affect the effectiveness of the appliance.
23. **DO NOT** use the **Shark®** Professional Steam & Spray™ Mop to clean up or absorb flammable or combustible materials.
24. **NEVER LEAVE THE SHARK® PROFESSIONAL STEAM & SPRAY MOP™ IN ONE SPOT ON ANY SURFACE FOR ANY PERIOD OF TIME WHEN THE CLEANING PAD IS ATTACHED OR WITH THE APPLIANCE TURNED ON AS THIS WILL DAMAGE YOUR FLOORS.**
25. When cleaning the **Shark®** Professional Steam & Spray™ Mop, unplug the power cord from the electrical outlet, and clean with a dry or damp cloth. Do not pour water or use alcohol, benzene or paint thinner on the unit.
26. Unplug the appliance before attaching or removing the pads.
27. Extreme caution should be exercised when using this appliance to clean stairs.
28. Never use the **Shark®** Professional Steam & Spray™ Mop without the cleaning pad attached.
29. **DO NOT** leave batteries in the unit. Remove the batteries when not in use.
30. **DO NOT** incinerate batteries or expose them to high temperatures. They may explode.
31. This unit is not intended for use with rechargeable batteries. Use of rechargeable batteries can damage the unit or lead to other hazards.
32. Leaks from battery cells can occur under extreme conditions. If the battery liquid, which is 20-35% solution of potassium hydroxide, gets on the skin, wash quickly with soap and water or neutralize with a mild acid such as lemon juice or vinegar. If the liquid gets into the eyes, flush them immediately with clean water for a minimum of 10 minutes. Seek medical attention.
33. Keep your work area well lit.
34. Store the **Shark®** Professional Steam & Spray Mop indoors in a cool, dry place.
35. To avoid circuit overload, do not operate another appliance on the same socket (circuit) as the **Shark®** Professional Steam & Spray™ Mop.
36. If an extension cord is absolutely necessary, an extension cord rated a minimum of 15 ampere, 14 gauge cord should be used. Cords rated for less amperage may overheat. Care should be taken to arrange cord so that it cannot be pulled or tripped over.

**⚠ WARNING:** Your **Shark®** Professional Steam & Spray™ Mop is designed to clean hard floor surfaces. Do not use on wood or tile floors that are highly worn, unfinished or have a wax or oil finish. Surfaces that have been treated with wax or some no wax floors may be damaged by the cleaning solution, therefore, it is always recommended to test an isolated area of the surface to be cleaned before proceeding. You should always check the use and care instructions from the floor manufacturer.

# SAVE THESE INSTRUCTIONS



This manual covers model number:  
SK460 40

### TECHNICAL SPECIFICATIONS

Voltage: 120V~, 60Hz.  
Power: 1050 Watts

**Euro-Pro, Shark, Steam & Spray, Steam Energized** and **Rotator** are trademarks of Euro-Pro Operating LLC. All other brand names may be trademarks of their respective owners.



**TOLL FREE: 1-800-798-7398**



# Contents

Thank you for  
purchasing  
the **Shark®**  
Professional Steam  
& Spray™ Mop.

Getting Started .....	2
Using Your <b>Shark®</b> Professional Steam & Spray™ Mop.....	4
Cleaning Your Hard Floors.....	4
Filling the Water Tank .....	4
Selecting Your Steam Setting .....	5
Using the Steam Energized™ Cleanser .....	5
Care and Maintenance.....	8
Ordering Replacement Parts.....	8
Troubleshooting Guide.....	9
Warranty .....	11



## Getting Started

When assembling your Professional Steam & Spray™ Mop there may be a little water in the Reusable Bottle. This is because we test all of our products 100% before you buy them, so you get a quality **Shark®** Professional Steam & Spray™ Mop.

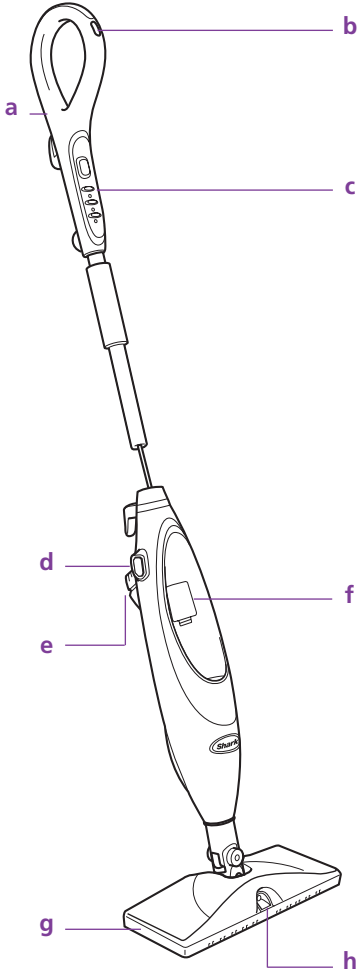

- a Handle
- b Spray Button
- c Steam Control
- d Plug Receptacle
- e Water Tank
- f Battery Compartment
- g Mop Head
- h Spray Nozzle

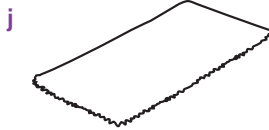

- i **Shark®** Steam Energized™ Cleanser
- j SaniFiber™ Disposable Pad
- k Washable Cleaning Pad
- l Filling Flask
- m Removable Power Cord
- n 4 AA batteries (not shown)

**NOTE:** Additional accessories such as cleaning pads and cleaning solutions are available for purchase at [www.sharkclean.com](http://www.sharkclean.com) or by calling 1-800-798-7398.



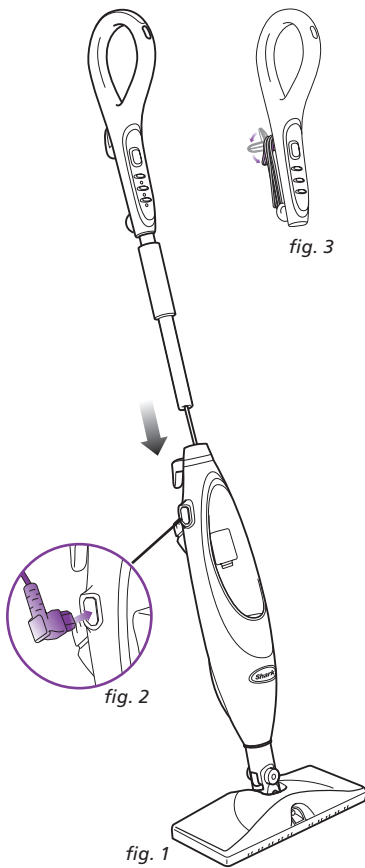

fig. 3

fig. 2

fig. 1

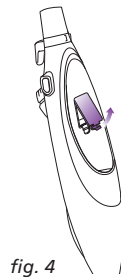

fig. 4

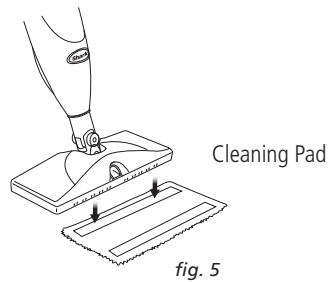

fig. 5

**! IMPORTANT:** Always make sure that the Professional Steam & Spray™ Mop is **UNPLUGGED** from the wall when not in use. Never change or remove the cleaning pad when the appliance is plugged into the wall. Use **ONLY** Steam Energized™ Cleanser. The addition of other chemicals or cleaning solutions may damage the appliance, void the warranty and could be unsafe for you and your family.

## ASSEMBLY

- 1 Insert the handle into the neck of the main body of the Professional Steam & Spray™ Mop. Push the mop handle and main body of the appliance together until you hear it “click” into place. (Fig. 1)
- 2 Insert the power cord plug into the power cord receptacle on the unit. (Fig. 2)
- 3 Hold the power cord and wrap it around the cord holders. (Fig. 3)
- 4 Remove the battery cover and insert the 4 AA batteries. (Fig. 4) Replace the battery cover.
- 5 Place the Professional Steam & Spray™ Mop unit on top of the cleaning pad. (Fig. 5)  
If using the washable cleaning pad, ensure that the Velcro® side is facing up and the tab is in the back. If using the Sanifiber™ disposable pad, ensure that the logo side is facing up.



## Using Your Professional Steam & Spray™ Mop

**! IMPORTANT:** When cleaning, do not use the Professional Steam & Spray™ Mop without attaching a Cleaning Pad, filling the water tank and inserting the Steam Energized™ Cleanser bottle first.



fig. 6

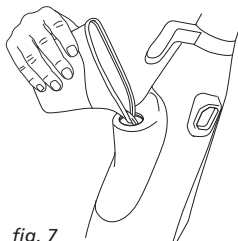

fig. 7

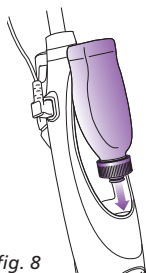

fig. 8

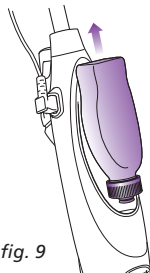

fig. 9

### Cleaning Your Hard Floors

#### Filling the Water Tank:

- 1 Turn the water tank cap counter clockwise and remove from the unit. (Fig. 6)
- 2 Using the filling flask, pour water into the water tank. Do not overfill. Replace the cap on the water tank. (Fig. 7)  
**NOTE:** To prolong the life of your Professional Steam & Spray™ Mop, we recommend using distilled water.
- 3 Insert the Steam Energized™ Cleanser bottle into the unit upside down. Push it down to make sure that it is well inserted. You will hear an audible "Click" when the Cleanser bottle is inserted properly. (Fig. 8)  
**NOTE:** To remove the Steam Energized™ Cleanser bottle hold it and pull it up. (Fig. 9)

**! IMPORTANT:** When you are using the mop for the first time, it might take longer than the normal 30 seconds to start steaming.

**! IMPORTANT:** Do not use on unsealed wood or unglazed ceramic floors. Do not use on wood or tile floors that are highly worn, unfinished or have a wax or oil finish. Surfaces that have been treated with wax or some no wax floors may be damaged by the cleaning solutions therefore it is always recommended to test an isolated area of the surface to be cleaned before proceeding. You should always check the use and care instructions from the floor manufacturer.

**! IMPORTANT:** Make sure the floors are swept or vacuumed before using the Professional Steam & Spray™ Mop.

Visit [www.sharkclean.com](http://www.sharkclean.com) for other great quick cleaning products to complement your Professional Steam & Spray™ Mop, such as the **Shark® Rotator™** vacuums.

- 4 Twist the quick release cord holder to unwrap the power cord completely. Plug into an electrical outlet.
- 5 Make sure that the Cleaning Pad is attached to the mop head.
- 6 The Steam Control button will flash blue. If the light does not turn on, reference the troubleshooting section on page 9.





fig. 10

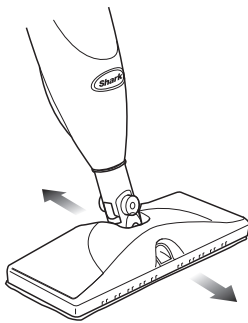

fig. 11

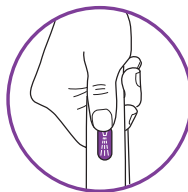

fig. 12

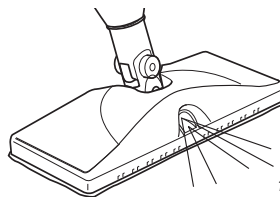

fig. 13

### Selecting Your Steam Setting:

- 1 Press the **ON/STANDBY** button once for **SaniFiber™** disposable pad setting (**SaniFiber™** disposable pad lighted setting indicator will illuminate). **SaniFiber™** disposable pad setting is designed to deliver the perfect amount of steam for your SaniFiber™ pads. It can also be used with your washable pad for a quick dusting. (Fig. 10)

Press the **ON/STANDBY** button a second time to activate the **MOP** setting. **MOP** setting is for normal, everyday steam cleaning.

Press the **ON/STANDBY** button a third time to activate the **SCRUB** setting. **SCRUB** setting is for heavy cleaning and will leave floors damp.

To better understand which steam setting to use for your cleaning task, turn to page 7.

- 2 Clean your floors with a forward and backward motion. (Fig. 11)
- 3 Press the **ON/STANDBY** button until the light flashes to stop the steam.
- ⚠ **WARNING:** Never stand on the Professional Steam & Spray™ Mop.
- 4 When the water tank is empty, the steam mop will stop producing steam. You can refill the water tank at any time as long as the mop is unplugged from the electrical outlet. Follow instructions on page 4.

### Using the Steam Energized™ Cleanser:

- 1 Make sure that the batteries are inserted into the battery compartment behind the reusable bottle. See page 3.
- 2 Press the Spray Button to apply solution onto the floor that is to be cleaned. (Fig. 12, Fig. 13)
- 3 If the Cleanser Bottle is empty, you can replace it at any time as long as the unit is unplugged from the electrical outlet.
- ⚠ **IMPORTANT:** Never leave the Professional Steam & Spray™ Mop with a damp/wet cleaning pad on any floor surface for any amount of time as this may damage the floor.
- 4 Once finished, step on the tab at the back of the cleaning pad and lift the unit to remove the cleaning pad.



## Using Your Professional Steam & Spray™ Mop - cont'd

### Frequently Asked Questions

- Q.** My Professional Steam & Spray™ Mop leaves a foam on hard floors.
- A.** The Professional Steam & Spray™ Mop Cleaning Pad is likely too saturated. Replace it with a clean, dry pad.
- Q.** My floors appear cloudy after cleaning.
- A.** The Professional Steam & Spray™ Mop Cleaning Pad may be dirty. Change the pad.

**OR**

- A.** The Professional Steam & Spray™ Mop Washable Cleaning Pad was washed with a powder detergent and may be damaged and require replacement. Never use powder detergents. Only use liquid detergent to launder the cleaning pads.

**OR**

- A.** The Professional Steam & Spray™ Mop may have been left in the same spot for too long with a wet cleaning pad. Never leave the unit with a wet pad in one spot for too long.

**OR**



- A.** This may be leftover from past cleaners that were used on the floor surface. Use the Professional Steam & Spray™ Mop a few more times and see if the leftover cloudiness is removed. If this does not work, we suggest rinsing the floor with water and letting it dry. One or more rinses generally removes the residue. A more stubborn case may require you to rinse the floor with a mix of one part vinegar to 2 parts water. Then use the Professional Steam & Spray™ Mop again with a clean pad.

### General Tips:

- Change the Cleaning Pad frequently for best results.
- Always vacuum floors before cleaning.



The **Shark® Professional Steam & Spray™ Mop** has three unique steam settings so you can use the perfect amount of steam for the cleaning task at hand. See below for tips on when to use each setting.

Setting	Ideal for These Surfaces	Recommended Usage
<b>SaniFiber™</b> DISPOSABLE PADS 	Laminate Bamboo Hardwood Marble	Ideal for use with SaniFiber™ pads for best performance
<b>MOP</b> 	Hardwood Marble Tile	Basic, everyday cleaning Remove spots and smaller messes Clean moderate and heavily-trafficked areas Sanitize floors
<b>SCRUB</b> 	Tile Stone Linoleum	Tough cleaning and removal of stuck-on messes and stains Deep clean heavily-trafficked areas Cut through heavy dirt and grime Sanitize floors

## Care and Maintenance

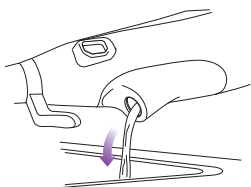

fig. 14

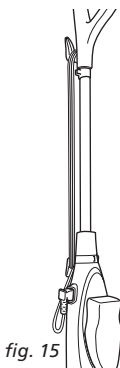

fig. 15

### AFTER USE AND STORAGE

- 1 When you have finished using the **Shark® Professional Steam & Spray™ Mop**, press the **ON/STANDBY** switch until the LED light turns flashing BLUE. This stops the unit from steaming. Unplug the cord from the electrical outlet and remove the Cleaning Pad from the unit.
- 2 Empty the water tank before storage. Remove the water tank cap and empty the tank over a sink. Replace the water cap. (**Fig. 14**)
- 3 Store the **Shark® Professional Steam & Spray™ Mop** in the upright position without the Cleaning Pad on the unit and away from children or in high traffic areas.
- 4 Wrap the power cord around the cord holders when not in use. (**Fig. 15**)



### CARE FOR YOUR WASHABLE CLEANING PAD

- 1 We recommend washing your Cleaning Pad separately from other fabrics to avoid picking up lint. **Only use liquid detergent (no powder detergent). Do not use any fabric softeners or bleach.** Line dry or dry on a low dryer setting.  
**NOTE:** We recommend replacing the cleaning pad after 20 washes.
- 2 If there are loose threads on the cleaning pad, carefully cut the thread with scissors. Do not pull on them or cut at the base.

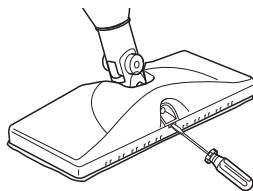
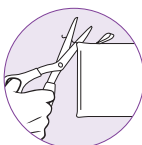

fig. 16

### CLEANING THE SPRAY NOZZLE:

- 1 If the spray nozzle becomes clogged, you can clean it by removing it from the mop head. To remove it, place a flat screwdriver underneath the nozzle and lift up. The nozzle will pop off. Run the spray nozzle under warm water to clean it out. Reinsert the spray nozzle by lining up its grooves with the inside of the nozzle hole. Push it in until it snaps into place. (**Fig. 16**)

### DECALCIFIFYING YOUR STEAM MOP

Calcium and mineral deposits can build up and impact the performance of your steam mop over time. To extend the life of your product we recommend that you use distilled water or a Shark® Water Filtration Bottle. Visit [www.SharkClean.com](http://www.SharkClean.com) to order.

## Ordering Replacement Parts

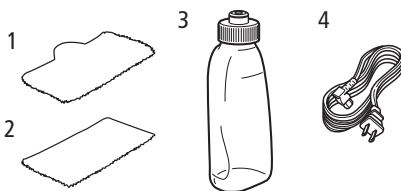

To order additional parts and accessories, feel free to contact us at [www.sharkclean.com](http://www.sharkclean.com) or call **1-800-798-7398**.

**NOTE:** Some parts may be available at your local retailer. Contact customer service for any other servicing.

PART	PART NO.
1 Washable Cleaning Pad	P141GHF
2 SaniFiber™ Disposable Cleaning Pads	P148WDISP
3 Steam Energized™ Cleanser	XGHFCL20
4 Removable Power Cord	XCORD25

## Troubleshooting Guide

PROBLEM	POSSIBLE REASONS & SOLUTIONS
<b>Shark® Professional Steam &amp; Spray™ Mop</b> will not turn on.	<ol style="list-style-type: none"> <li>1. Make sure that the power cord is firmly inserted into the unit power cord receptacle and in the electrical outlet.</li> <li>2. Check your fuse or breaker.</li> <li>3. If your unit still does not work, call Customer Service at <b>1-800-798-7398</b>.</li> </ol>
<b>Shark® Professional Steam &amp; Spray™ Mop</b> will not make steam.	<ol style="list-style-type: none"> <li>1. Is there water in the water tank? If not, add water following instructions on page 4.</li> <li>2. Is the water intake tube stuck in the top of the water tank? If so, push it down so it reaches the bottom of the tank.</li> <li>3. If the unit still does not make steam, follow decalcification instructions on page 8.</li> </ol>
Cannot select steam setting/ flashing blue light remains on.	<ol style="list-style-type: none"> <li>1. If you have already plugged in the power cord, unplug and re-plug into another electrical wall outlet. This may reset the Standby mode.</li> <li>2. Add water to the water tank and press the On/Standby button to select a steam setting.</li> <li>3. If your unit still does not work, call Customer Service at <b>1-800-798-7398</b>.</li> </ol>
<b>Shark® Professional Steam &amp; Spray™ Mop</b> is squirting foam from the spray nozzle.	<ol style="list-style-type: none"> <li>1. The Cleanser Bottle is not firmly inserted into the unit. Make sure that you hear an audible "Click" when you insert the Cleanser Bottle into the appliance.</li> <li>2. There may be air in the system. Hold down the spray button for 5 to 10 seconds to flush the system.</li> </ol>
<b>Shark® Professional Steam &amp; Spray™ Mop</b> doesn't spray.	<ol style="list-style-type: none"> <li>1. Make sure that the batteries are inserted into the battery compartment behind the Cleanser Bottle. If there are batteries, then insert new batteries.</li> <li>2. Make sure that the Cleanser Bottle is inserted all the way in. You should hear an audible "Click" when inserted.</li> <li>3. Check that there is enough cleaning solution in the Cleanser Bottle. If not, insert a new bottle of Steam Energized™ Cleanser.</li> <li>4. There may be air in the system. Hold down the spray button for 5 to 10 seconds until solution comes out of the spray nozzle.</li> <li>5. The spray nozzle at the front of the unit where the spray comes out may be clogged. See page 8 for instructions on cleaning the spray nozzle.</li> </ol>
The Cleanser Bottle fell out.	<ol style="list-style-type: none"> <li>1. The unit is not meant to be turned upside down. When upside-down, the Cleanser Bottle is at risk for falling out of its cradle. Please do not turn the unit upside-down. If it is necessary to turn the unit upside-down, remove the Cleanser Bottle first.</li> </ol>
<b>Shark® Professional Steam &amp; Spray™ Mop</b> left a white spot on the floor.	<ol style="list-style-type: none"> <li>1. Check to see if the cleaning pad is soaked through. We recommend that you unplug the unit and replace the cleaning pad.</li> <li>2. Make sure that the cleaning pad is attached correctly.</li> </ol>
<b>Shark® Professional Steam &amp; Spray™ Mop</b> leaves water on the floor.	<ol style="list-style-type: none"> <li>1. Do not leave the Steam &amp; Spray™ Mop on the floor with a damp cleaning pad.</li> <li>2. If you are using tap water, we recommend switching to distilled water.</li> <li>3. Make sure that the cap is securely placed on the water tank.</li> </ol>
Floors are cloudy, spotty or streaky after cleaning.	<ol style="list-style-type: none"> <li>1. The cleaning pad may be dirty. Change the cleaning pad.</li> <li>2. If the washable cleaning pad was washed with powder detergent, then it may be damaged and require replacement. Replacement pads are available at <a href="http://www.sharkclean.com">www.sharkclean.com</a>.</li> <li>3. The mop may have been left in one spot for too long.</li> <li>4. This may be leftover from past cleaners used on the floor surface. Use the mop a few more times again with a clean pad and see if the cloudiness is removed. If this does not work, we suggest rinsing the floor with water, letting it dry and then steam mopping again with a clean pad. One or more rinses generally removes the residue. A more stubborn case may require you to rinse the floor with a mix of one part vinegar and two parts water.</li> </ol>
<b>Shark® Professional Steam &amp; Spray™ Mop</b> is hard to push.	<ol style="list-style-type: none"> <li>1. Make sure the cleaning pad is attached correctly.</li> <li>2. Check to see if the cleaning pad is excessively dirty. If so, replace with a clean pad.</li> </ol>



## Notes

---

---

---

---

---

---

---

---

---

---

---

---

---

---

---

---

---

---

---

---

---

---

---





## ONE (1) YEAR LIMITED WARRANTY

**EURO-PRO Operating LLC** warrants this product to be free from defects in material and workmanship for a period of one (1) year from the date of the original purchase, when utilized for normal household use, subject to the following conditions, exclusions and exceptions.

If your appliance fails to operate properly while in use under normal household conditions within the warranty period, return the complete appliance and accessories, freight prepaid. For assistance with warranty service options or customer support, please call our customer care and product specialists at , call 1 (800) 798-7398 or visit our website [www.sharkclean.com](http://www.sharkclean.com).

If the appliance is found to be defective in material or workmanship, **EURO-PRO Operating LLC** will repair or replace it free of charge. Proof of purchase is required and a fee of \$19.95 will apply to cover the cost of return freight. \*

The liability of **EURO-PRO Operating LLC** is limited solely to the cost of the repair or replacement of the unit at our option. This warranty does not cover normal wear of parts and does not apply to any unit that has been tampered with or used for commercial purposes. This limited warranty does not cover damage caused by misuse, abuse, negligent handling or damage due to faulty packaging or mishandling in transit. This warranty does not cover damage or defects caused by or resulting from damages from shipping or repairs, service or alterations to the product or any of its parts, which have been performed by a repair person not authorized by **EURO-PRO Operating LLC**.

This warranty is extended to the original purchaser of the unit and excludes all other legal and/or conventional warranties. The responsibility of **EURO-PRO Operating LLC** warranty if any, is limited to the specific obligations expressly assumed by it under the terms of the limited warranty. **In no event is EURO-PRO Operating LLC** liable for incidental or consequential damages of any nature whatsoever. Some states/provinces do not permit the exclusion or limitation of incidental or consequential damages, so the above may not apply to you.

This warranty gives you specific legal rights, and you may also have other rights which vary from state to state or province to province.

**\*Important: Carefully pack item to avoid damage in shipping. Be sure to include proof of purchase date and to attach tag to item before packing with your name, complete address and phone number with a note giving purchase information, model number and what you believe is the problem with the item. We recommend you insure the package (as damage in shipping is not covered by your warranty). Mark the outside of your package "ATTENTION CUSTOMER SERVICE". We are constantly striving to improve our products, therefore the specifications contained herein are subject to change without notice.**

### Product Registration

Please visit [www.sharkclean.com](http://www.sharkclean.com) or call **1-800-798-7398** to register your new **Shark®** product within ten (10) days of purchase. You will be asked to provide the store name, date of purchase and model number along with your name and address.

The registration will enable us to contact you in the unlikely event of a product safety notification. By registering you acknowledge to have read and understood the instructions for use, and warnings set forth in the accompanying instructions.



EURO-PRO Operating LLC

U.S.: Newton, MA 02459

Canada: Ville St. Laurent, Québec H4S 1A7

**1-800-798-7398**

**[www.sharkclean.com](http://www.sharkclean.com)**

COPYRIGHT © 2013 EURO-PRO OPERATING LLC

PRINTED IN CHINA

**Euro-Pro, Shark, Steam & Spray, SanFiber and Rotator** are trademarks of Euro-Pro Operating LLC.

SK460\_E.130704.2-DG

Illustrations may differ from actual product.