

# SENCO®

# FRAMING NAILERS

Operating Instructions  
Instrucciones de Operacion  
Mode d'Emploi



**FramePro®  
700XP Series**

**Full Round Head**

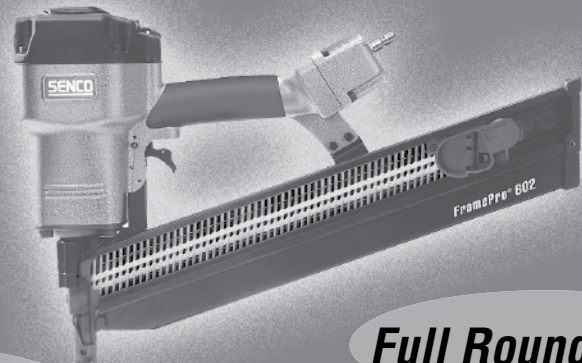

**FramePro®  
721**

**FramePro®  
600 Series**

**Full Round Head**

Questions? Comments?  
call Senco's toll-free Action-line:  
1-800-543-4596  
e-mail: [toolprof@senco.com](mailto:toolprof@senco.com)

Senco Products, Inc.  
8485 Broadwell Road  
Cincinnati, Ohio 45244

Visit our Website [www.senco.com](http://www.senco.com) © 2000, 2008 by Senco Products, Inc.



Warnings for the safe use of this tool are included in this manual.  
Los avisos para el uso seguro de esta herramienta están incluidos en este manual.  
Les consignes pour l'utilisation en toute sécurité de cet outil se trouvent dans ce manuel.

HVFN020 Revised January 30, 2008  
(Replaces 2/24/04)

English	Español	Français
---------	---------	----------

TABLE OF CONTENTS	TABLA DE MATERIAS	TABLE DES MATIERES
	Usó de la	
Tool Use	1 Herramienta	1 Utilisation de l'outil
Maintenance	7 Mantenimiento	7 Entretien
Troubleshooting	9 Identificación de	9 Dépannage
Specifications	10 Fallas	9 Spécifications
Options	14 Especificaciones	10 Options
Accessories	15 Opciones	14 Accessoires
	Accesorios	15

EMPLOYER'S RESPONSIBILITIES	RESPONSABILIDADES DEL EMPLEADOR	RESPONSABILITÉS DE L'EMPLOYEUR
Employer must enforce compliance with the safety warnings and all other instructions which accompany this tool as shipped from the manufacturer.	El empleador debe hacer cumplir las advertencias de seguridad y todas las otras instrucciones que acompañan a esta herramienta como se la despacha desde el fabricante.	L'employeur doit faire appliquer les consignes de sécurité et toutes les autres instructions qui accompagnent cet outil tel qu'il est livré par son constructeur.
Keep this manual available for use by all people assigned to the use of this tool.	Mantenga este manual disponible para que lo usen todas las personas destinadas a hacer uso de esta herramienta.	Ayez ce manuel à la disposition de toutes les personnes chargées d'utiliser cet outil.
For personal safety and proper operation of this tool, read and understand all of these instructions carefully.	Por razones de seguridad personal y la adecuada operación de esta herramienta, lea y comprenda todas estas instrucciones cuidadosamente.	Pour assurer la sécurité personnelle et le bon emploi de cet outil, lisez et assimilez soigneusement toutes ces instructions.

Tool Use	Usó de la Herramienta	Utilisation de l'Outil
English	Español	Français

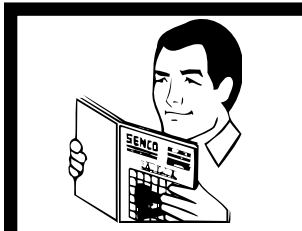

- Read and understand "SAFETY INSTRUCTIONS" manual shipped with this tool before using tool.

- Antes de usar la herramienta lea y comprenda el manual "INSTRUCCIONES DE SEGURIDAD" despachado con ella.

- Lisez et assimilez le manuel "INSTRUCTIONS DE SÉCURITÉ" livré avec cet outil avant de l'utiliser.

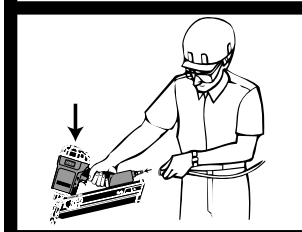

- Keep tool pointed away from yourself and others and connect air to tool.

- Mantenga la herramienta apuntando en dirección opuesta de usted y de otros y conecte el aire a la manguera.

- Maintenez l'outil pointé à l'écart d'autres personnes et de vous-même et raccordez l'air à l'outil.

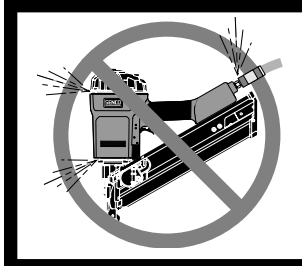

- Never use a tool that leaks air or needs repair.

- Nunca use una herramienta que tenga escapes de aire o que necesite ser reparada.

- N'utilisez jamais un outil qui a des fuites d'air ou qui a besoin d'être réparé.

## English

## Español

## Français

## SN70

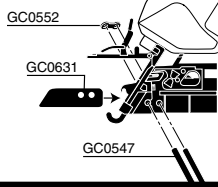

## SN70

- Nail Guide (GC0631) should be installed when driving nails shorter than 2 1/2" in length.

## SN70

- Se recomienda instalar la Guía Para Clavos (GC0631) cuando se pretenda disparar clavos menores de 2 1/2" de largo.

## SN70

- Le guide clous (GC0631) doit être installé lorsque l'on veut passer des clous plus courts que 2 1/2" (65 mm) en longueur.

## FramePro

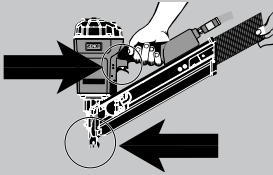

- To Load: Insert strip of nails into rear of magazine. Use only genuine SENCO fasteners. Do not load with safety element or trigger depressed.

- Para cargar: Inserte la tira de clavos en la parte de atrás del área de almacenamiento. Use solamente sujetadores SENCO auténticos. No cargue con el disparo o la seguridad oprimidos.

- Pour charger : Introduisez une bande de clous dans la partie arrière du magasin. Utilisez uniquement les véritables clous SENCO. Veillez à ne pas appuyer sur le palpeur de sécurité ou sur la détente quand vous chargez.

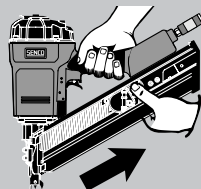

- Pull feeder shoe back.

- Tire la zapata del alimentador.

- Tirez le poussoir en arrière.

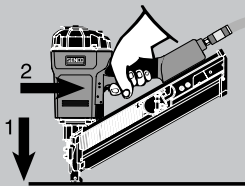

- With a Contact Acuation trigger, nails can be driven two ways:

- Las herramientas con gatillo de accion doble pueden ser disparadas de dos maneras:

- Les appareils équipés de déclenchement "au touché / par gâchette" peuvent être utilisés de 2 façons différentes :

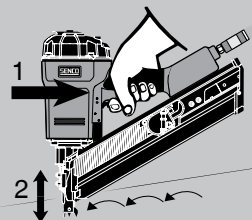

- a) Position safety element against work surface and pull trigger..."Trigger Fire."
- b) To drive a nail, pull trigger and push safety element against the work surface. Each time the safety element is pushed against the work surface a nail will be driven. This "bottom-fire" mode of operation is preferred when high production, rapid fastener placement is desired.

- a) Oprima el seguro contra la superficie de trabajo y apriete el gatillo...Disparo de gatillo.
- b) Para impulsar un clavo, oprima el disparador y deprima el elemento de seguridad contra la superficie de trabajo. Cada vez que deprima el elemento de seguridad contra la superficie de trabajo, impulsará un clavo. Este modo de operación de "disparo inferior" o "por rebote" es el preferido cuando se desea alta productividad y rápida colocación del clavo.

- a) Déclenchement par "gâchette" : Appliquer le palpeur de sécurité de l'appareil à l'endroit désiré et activer la gâchette.
- b) Pour planter un clou, tirez sur la détente et poussez l'élément de sécurité contre la surface de travail. Chaque fois que l'élément de sécurité est poussé contre la surface de travail un clou est planté. Le mode de fonctionnement en "tir continu" est préférable si vous désirez placer des attaches rapidement avec forte productivité.

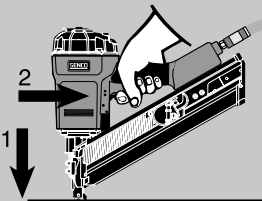

- With a Single Sequential trigger, nails can only be driven one way. 1) First depress safety element against work surface 2) then pull trigger. This feature is helpful when precise fastener placement is required.

- Las herramientas con "Gatillo Restringido" solamente se pueden disparar con el gatillo. 1) Primero presione el elemento de seguridad contra la superficie de trabajo y 2) después apriete el gatillo. Esta característica es útil cuando se requiere precisión en la colocación de los sujetadores.

- Avec une gâchette "restrictive", les clous ne peuvent être tirés que dans une seule direction. 1) Appuyer d'abord le palpeur de sécurité sur la surface de travail, 2) puis tirer sur la gâchette. Cette fonction est utile pour un placement précis de projectiles.

- Read the "Customer Satisfaction and Safety Reminder" (CSSR) in the tool and fastener boxes for safety information regarding the Dual Action and Restrictive triggers. Under certain conditions, the Restrictive trigger may reduce the possibility of injury to you or to others working with you.

- Lea el "Recordatorio de Seguridad y Satisfacción del Cliente" (CSSR) en las cajas de sujetadores y de las herramientas para información sobre seguridad de los Gatillos Restringido y de Acción Dual. Bajo ciertas condiciones, el Gatillo Restringido puede reducir la posibilidad de heridas a su persona o a otros que trabajen con usted.

- Lire le "Rapport de Sécurité et Satisfaction du Client" (CSSR) dans les boîtes à outils et fixations pour les informations de sécurité concernant les Détonnes à Double Action et à Restriction. Dans certaines circonstances, la Détonne à Restriction peut réduire la possibilité de se blesser ou de blesser d'autres personnes.

## SN60MC

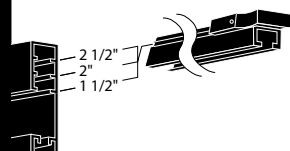

- To Load: Position the Nail Guide for the fastener length. Insert strip of nails into rear of magazine. Use only genuine SENCO fasteners. Do not load with safety mechanism or trigger depressed.

- Para cargar: Coloque la guía del clavo que corresponda a la longitud del clavo. Inserte la tira de clavos en la parte de atrás del área de almacenamiento. Use solamente sujetadores SENCO auténticos. No cargue con el disparo o la seguridad oprimidos.

- Pour charger : Positionner le guide agrafe pour la longueur de l'agrafe . Introduisez une bande de clous dans la partie arrière du magasin. Utilisez uniquement les clous d'origine SENCO. Veillez à ne pas appuyer sur le palpeur de sécurité ou sur la détente quand vous chargez.

**Tool Use**

**Uso de la Herramienta**

**Utilisation de l'Outil**

**English**

**Español**

**Français**

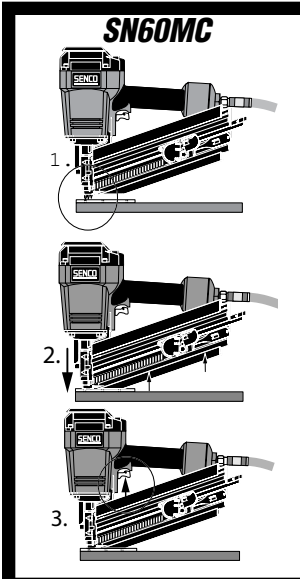

- This tool is equipped with a movable rail safety mechanism. To activate the tool:
  - 1.) Before each firing, be sure to position the first nail through the hole in the metal connector. If the nail is not positioned properly it could ricochet and hurt someone.
  - 2.) Depress the tool against the work surface. This will cause the rail safety mechanism to move upward. To prevent damaging nail strips and jamming, do not push the tool forward when positioning the first nail or activating the tool.
  - 3.) Pull the trigger to activate the tool.

- Esta herramienta esta equipada con un mecanismo de seguridad de riel móvil:
  - 1.) Antes de cada disparo, asegúrese de que el primer clavo este dentro del orificio de conector metálico. Si el clavo no está colocado en el lugar apropiado, el sujetador puede rebotar y herir a alguien.
  - 2.) Empuje la herramienta contra la superficie de trabajo. Esto hará que el mecanismo de seguridad de riel se mueva hacia arriba. Para prevenir atrancamiento y daño a las Tiras de clavos, no empuje hacia adelante cuando apunte el primer clavo o cuando active la herramienta.
  - 3.) Oprima el gatillo para activar la herramienta.

- Cet outil est équipé d'un mécanisme mobile de sécurité sur le rail. Pour activer l'outil:
  - 1.) Avant chaque tir, être sur de positionner le premier clou dans le trou du connecteur métal. Si le clou n'est pas positionné correctement, il pourrait ricochet et blesser quelqu'un.
  - 2.) Appuyer l'outil contre la surface de travail. Cela amènera le mécanisme de sécurité du rail à bouger vers le haut. Pour éviter d'endommager ou de coincer les rouleaux d'agrafes, ne pas pousser l'outil vers l'avant en positionnant ou en actionnant l'outil.
  - 3.) Tirer la gachette pour activer l'outil.

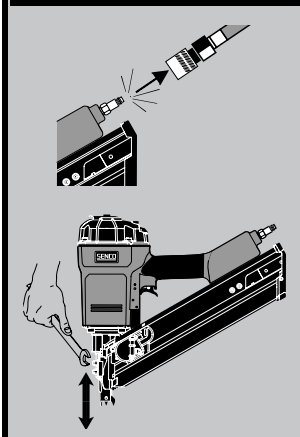

- To adjust the depth the fastener is driven, first disconnect the air supply.
- Using a socket head cap screw wrench, or a screwdriver, adjust the safety element to achieve desired depth.

- Para ajustar la profundidad de clavo o engrapado, debe primero desconectar el aire.
- Con un desarmador o una llave "Allen" ajuste el seguro para eudir la profundidad deseada.

- Pour ajuster la profondeur à laquelle le clou est enfoncé, déconnecter tout d'abord l'appareil de la source d'air comprimé.
- A l'aide d'une clé ou d'un tournevis, ajuster la position de l'élément de contact pour obtenir la pénétration du clou voulue.

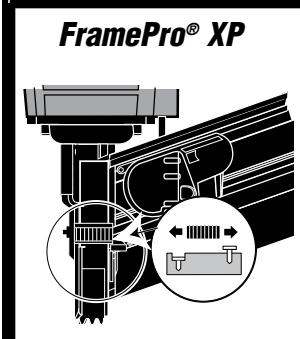

- To adjust the depth the fastener is driven, first disconnect the air supply. Using your thumb or index finger, rotate wheel to adjust the Depth Control safety element to achieve desired depth.

- Para ajustar la profundidad de sujetador, dede primero desconectar el aire. Usando el dedo pulgar o el dedo indice, rote la manivela para ajustar el seguro a la profundidad deseada.

- Pour ajuster la profondeur à laquelle le projectile est enfoncé, déconnecter tout d'abord l'appareil de la source d'air comprimé. A l'aide du pouce ou de l'index, faire tourner la molette pour ajuster la position du palpeur de sécurité.

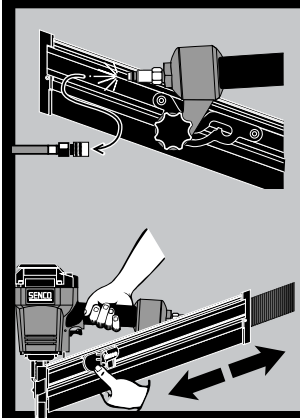

- Should a nail jam occur, disconnect air supply.
- Release the feeder shoe and slide it forward. Remove fasteners from the tool.

- Si se produce un atascamiento de un clavo, desconecte el suministro de aire.
- Suelte el alimentador y deslícelo hacia adelante. Retire los sujetadores de la herramienta.

- Au cas ou il se produirait un coinçage de clous, coupez l'alimentation en air.
- Relâcher le poussoir et le faire glisser vers l'avant. Enlever les projectiles.

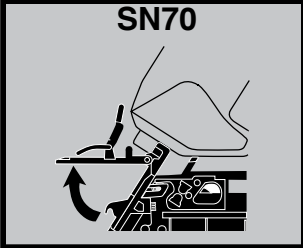
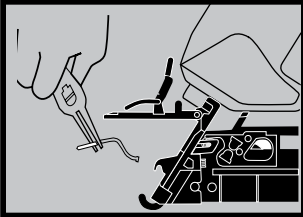
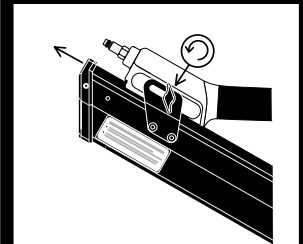
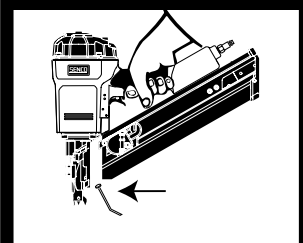
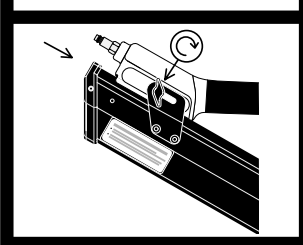
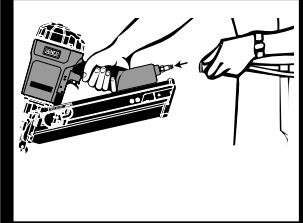
	Tool Use	Uso de la Herramienta	Utilisation de l'Outil
	English	Español	Français
 <p><b>SN70</b></p>	<ul style="list-style-type: none"> <li>● Release E-Z Clear latch and open door.</li> </ul>	<ul style="list-style-type: none"> <li>● Suelte el pestillo de alivio fácil (E-Z) y abra la puerta.</li> </ul>	<ul style="list-style-type: none"> <li>● Relâchez le loquet transparent "E-Z" et ouvrez le volet de front.</li> </ul>
	<ul style="list-style-type: none"> <li>● Remove jammed fastener. Close door and latch.</li> </ul>	<ul style="list-style-type: none"> <li>● Remueva el sujetador atascado. Cierre la puerta con pestillo.</li> </ul>	<ul style="list-style-type: none"> <li>● Enlevez le clou coincé. Fermez le volet de front et le loquet.</li> </ul>
	<ul style="list-style-type: none"> <li>● Loosen locking knob at the rear of the tool by hand. Pull magazine back.</li> </ul>	<ul style="list-style-type: none"> <li>● Con la mano, afloje la manivela la localizada en la parte posterior. Empuje y jale la carrillera hacia atrás.</li> </ul>	<ul style="list-style-type: none"> <li>● Desserrer à la main la molette de verrouillage à l'arrière de l'outil. Tirer en arrière le magasin.</li> </ul>
	<ul style="list-style-type: none"> <li>● Clear jammed fastener from guide body.</li> </ul>	<ul style="list-style-type: none"> <li>● Libre el sujetador de la placa de nariz.</li> </ul>	<ul style="list-style-type: none"> <li>● Extraire le clou coincé du front de l'appareil.</li> </ul>
	<ul style="list-style-type: none"> <li>● Slide magazine back into position and tighten locking knob.</li> </ul>	<ul style="list-style-type: none"> <li>● Deslice la carrillera a su posición original y apriete la manivela.</li> </ul>	<ul style="list-style-type: none"> <li>● Glisser le magasin vers sa position initiale et resserrer la molette de verrouillage à la main.</li> </ul>
	<ul style="list-style-type: none"> <li>● Connect air supply and replace fasteners. Pull feeder shoe back.</li> </ul>	<ul style="list-style-type: none"> <li>● Conecte la línea de aire y reemplace los clavos. Tire la zapata del alimentador.</li> </ul>	<ul style="list-style-type: none"> <li>● Reconnectez la conduite d'air comprimé et rechargez le magasin. Tirez le poussoir en arrière.</li> </ul>

**Tool Use**

**Uso de la Herramienta**

**Utilisation de l'Outil**

**English**

**Español**

**Français**

**FramePro®**

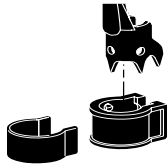

- The tool can be converted for non-toenail (flat surface) applications by adding the no-mar pad.

- La Herramienta puede ser convertida para aplicaciones de clavado no inclinado, agregando el cojinete no-mar.

- Possibilité de modification de l'appareil, en ajoutant une protection sur la sécurité, pour des clouages sur surfaces plates.

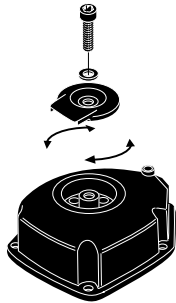

- The deflector can be rotated to change the direction of the exhaust air. Disconnect air supply, loosen cap screw with a hex wrench, and then rotate deflector to desired direction. Tighten cap screw.

- El deflector puede rotarse para cambiar la dirección del aire expedido por el mofle. Desconecte el aire, afloje los tornillos de la tapa y rote el deflector a la dirección deseada. Apriete los tornillos de la tapa.

- Le déflecteur peut être orienté différemment pour changer la direction de l'échappement d'air. Déconnecter l'appareil de la source d'air comprimé, dévisser la vis de maintien du déflecteur et faire pivoter celui-ci jusqu'à la position voulue. Resserrer la vis de maintien.

**SNG6MC**

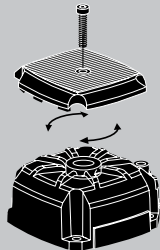

- The deflector can be rotated to change the direction of the exhaust air. Disconnect air supply, loosen cap screw with a socket head cap screw wrench, and then rotate deflector to desired location. Tighten cap screw.

- El deflector puede rotarse para cambiar la dirección del aire expedido por el mofle. Desconecte el aire, afloje los tornillos de la tapa y rote el deflector a la posición deseada. Apriete los tornillos de la tapa.

- Le déflecteur peut être orienté différemment pour changer la direction de l'échappement d'air. Déconnecter l'appareil de la source d'air comprimé, dévisser la vis de maintien du déflecteur et faire pivoter celui-ci jusqu'à la position voulue. Resserrer la vis de maintien.

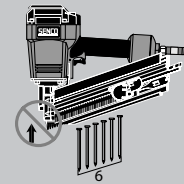

- This tool is equipped with a lockout feature that prevents the tool from being activated when there are 6 or less nails in the magazine. The safety mechanism will be locked in the undepressed position until more nails are loaded into the magazine.

- Esta herramienta esta equipada con un seguro que previene que la herramienta sea activada cuando la carrillera contenga menos de 6 clavos. El seguro se mantendra en la posición deprimida hasta que mas clavos se coloquen en la carrillera.

- Cet appareil est équipé d'un dispositif de blocage qui permet d'éviter qu'il soit activé lorsqu'il reste 6 clous ou moins dans le magasin. Le palpeur de sécurité sera bloqué en position "repos" = non enfoncé, jusqu'à ce que plus de clous aient été placés dans le magasin.

**FramePro®**

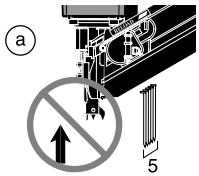

- This tool is equipped with a lockout feature that prevents the tool from being activated under these conditions:

- Esta herramienta está equipada con una función de seguridad que impide a la misma activarse en estas condiciones:

- Cet outil est équipé d'un dispositif de blocage pour empêcher l'outil d'être activé dans les conditions suivantes :

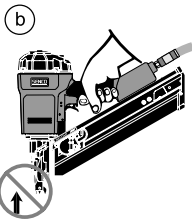

- a) when approximately five nails remain in the magazine, the safety element will be locked in the undepressed position until more nails are loaded into the magazine. (Safety Note: Due to various nail sizes, tool may lockout once but still drive a nail if safety element is depressed again.)

- a) Cuando queden aproximadamente cinco clavos en el cargador el seguro quedara en posición inactiva, hasta que introduzca más clavos en el cargador (Nota de seguridad: debido a la variedad de tamanos de los clavos, la herramienta se puede desactivar una vez, pero aún disparar un clavo si se vuelve a presionar el elemento de seguridad).

- a) Quand il reste approximativement cinq projectiles dans le magasin, l'élément de sécurité se bloque en position basse jusqu'à ce que le magasin soit rechargé. (Note de Sécurité : Du à la taille diverse des pointes, l'outil peut se bloquer tout en étant capable de tirer une pointe si le palpeur de sécurité est appuyé.)

- b) when the magazine is pulled back, the safety element will be locked in the undepressed position until the magazine is moved forward and locked into place.

- b) Cuando el cargador se jala hacia atras el seguro quedara en posición inactiva hasta que el cargador se mueva hacia adelante y se coloque en su lugar.

- b) Quand le magasin est tiré vers l'arrière, le palpeur de sécurité se bloque en position basse jusqu'à ce que le magasin soit remis en place et enclenché.

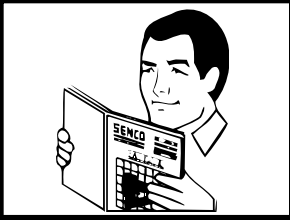
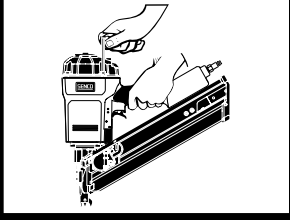
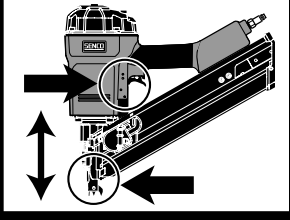
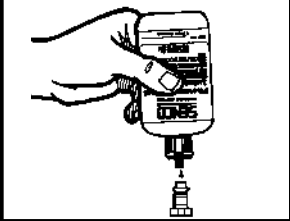
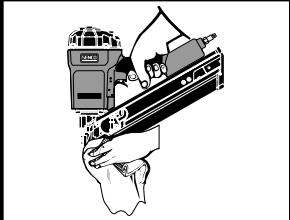
	Maintenance	Mantenimiento	Entretien
	English	Español	Français
	<ul style="list-style-type: none"> <li>● Read and understand "SAFETY INSTRUCTIONS" manual shipped with this tool before using tool.</li> </ul>	<ul style="list-style-type: none"> <li>● Antes de usar la herramienta lea y comprenda el manual "INSTRUCCIONES DE SEGURIDAD" despachado con ella.</li> </ul>	<ul style="list-style-type: none"> <li>● Lisez et assimilez le manuel "INSTRUCTIONS DE SÉCURITÉ" livré avec cet outil avant de l'utiliser.</li> </ul>
	<ul style="list-style-type: none"> <li>● All screws should be kept tight. Loose screws result in unsafe operation and parts breakage.</li> </ul>	<ul style="list-style-type: none"> <li>● Todos los tornillos tienen que mantenerse apretados. Los tornillos sueltos pueden producir una operación no segura y quebraduras de partes.</li> </ul>	<ul style="list-style-type: none"> <li>● Toutes les vis doivent être maintenues serrées à fond. Les vis desserrées entraînent un manque de sûreté du fonctionnement et la rupture de pièces.</li> </ul>
	<ul style="list-style-type: none"> <li>● With tool disconnected, make daily inspection to assure free movement of safety element and trigger. Do not use tool if safety element or trigger sticks or binds.</li> </ul>	<ul style="list-style-type: none"> <li>● Con la herramienta desconectada, haga inspecciones diarias para asegurar el movimiento libre del seguro y del gatillo. No use la herramienta si el seguro o el gatillo se atorán.</li> </ul>	<ul style="list-style-type: none"> <li>● L'outil étant séparé de l'alimentation en air, effectuez une inspection journalière pour assurer le libre mouvement du palpeur de sécurité et de la détente. N'utilisez pas l'outil si le palpeur de sécurité ou la détente colle ou se coince.</li> </ul>
	<ul style="list-style-type: none"> <li>● Squirt Senco pneumatic oil (5 to 10 drops) into the air inlet twice daily (depending on frequency of tool use). Other oils may damage O-rings and other tool parts.</li> </ul>	<ul style="list-style-type: none"> <li>● Aplique aceite neumático SENCO en la entrada de aire dos veces al día (dependiendo en la frecuencia de uso 5 A 10 Gotas). Otros aceites pueden dañar los anillos en "O" y otras piezas de la herramienta.</li> </ul>	<ul style="list-style-type: none"> <li>● Avec une burette, placer 5 à 10 gouttes d'huile pneumatique dans l'arrivée d'air deux fois par jour (dépend de l'intensité de l'utilisation de l'appareil). D'autres huiles pourraient endommager les joints toriques et d'autres pièces de l'outil.</li> </ul>
	<ul style="list-style-type: none"> <li>● Wipe tool clean daily and inspect for wear. Use non-flammable cleaning solutions only if necessary—DO NOT SOAK. <b>Caution:</b> Such solutions may damage O-rings and other tool parts.</li> </ul>	<ul style="list-style-type: none"> <li>● Solamente si es necesario use soluciones para limpieza no flamables -NO LA REMOJE. Precaución: Tales soluciones pueden dañar los empaques y otras partes de la herramienta.</li> </ul>	<ul style="list-style-type: none"> <li>● Nettoyez l'outil chaque jour à l'aide d'un chiffon et inspectez-le pour déceler une éventuelle usure. Utilisez uniquement des solvants non inflammables en cas de nécessité—NE LE FAITES PAS TREMPER ! <b>Attention :</b> De tels produits peuvent endommager les joints et autres pièces de l'appareil.</li> </ul>

# Notes

---

---

---

---

---

---

---

---

---

---

---

---

---

---

---

---

---

---

---

---

---

---

---

---



**SN70**

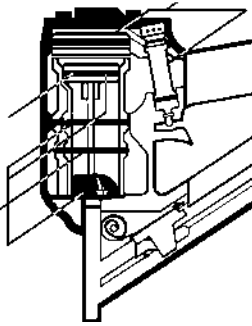

**SN60MC**

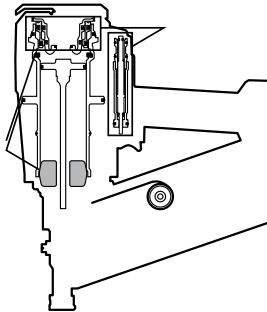

**FramePro®**

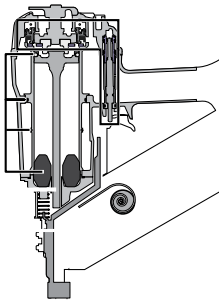

**WARNING**

Repairs other than those described here should be performed only by trained, qualified personnel. Contact SENCO for information at 1-800-543-4596.

- Read and understand "SAFETY INSTRUCTIONS" manual shipped with this tool before using tool.

**ALERTA**

Las reparaciones, fuera de aquellas descritas aquí, deben de ser llevadas a cabo solamente por personal entrenado y calificado. Póngase en contacto con SENCO para información 1-800-543-4596.

- Antes de usar la herramienta lea y comprenda el manual "INSTRUCCIONES DE SEGURIDAD" despachado con ella.

**AVERTISSEMENT**

Les réparations autres que celles décrites ici doivent être réalisées uniquement par du personnel qualifié ayant reçu la formation appropriée. Pour toute information, prenez contact avec SENCO par téléphone en appelant Le Distributeur agréé.

- Lisez et assimilez le manuel "INSTRUCTIONS DE SÉCURITÉ" livré avec cet outil avant de l'utiliser.

**SYMPTOM**

Air leak near top of tool / Sluggish operation

**SOLUTION**

Verify air supply / tighten screws or install Repair Kit.

**SÍNTOMA**

El aire se escapa cerca de la parte superior de la herramienta / Operación lenta.

**SOLUCIÓN**

Apriete los tornillos / Verifique el suministro de aire o instale el Juego de Partes.

**SYMPTÔME**

Fuite d'air près du sommet de l'outil / fonctionnement lent.

**SOLUTION**

Serrez les vis à fond / vérifiez l'alimentation en air ou remplacez les pièces.

**SYMPTOM**

Air leak near bottom of tool / Poor return.

**SOLUTION**

Clean tool / tighten screws or install Repair Kit.

**SÍNTOMA**

El aire se fuga cerca de la parte inferior de la herramienta / Mal

**SOLUCIÓN**

Apriete los tornillos / Limpié la herramienta o instale el Juego de Partes.

**SYMPTÔME**

Fuite d'air près de la base de l'outil / retour inadéquat.

**SOLUTION**

Serrez les vis à fond / nettoyez l'outil ou remplacez les pièces.

**SYMPTOM**

Other problems.

**SOLUTION**

Contact SENCO.

**SÍNTOMA**

Otros problemas.

**SOLUCIÓN**

Póngase en contacto con SENCO.

**SYMPTÔME**

Autres problèmes.

**SOLUTION**

Prenez contact avec SENCO.

Specifications

Especificaciones

Specifications

English

Español

Français

**SN70**

Code	A	
	inches	mm
JF25	2 1/2	65
GE21	2	50
GE24	2 3/8	60
GC21	2	50
GC23	2 1/4	57
GC24	2 3/8	60
GC25	2 1/2	65
HC27	3	75
KC27	3	75
KC28	3 1/4	83
KC29	3 1/2	90
HF27	3	75

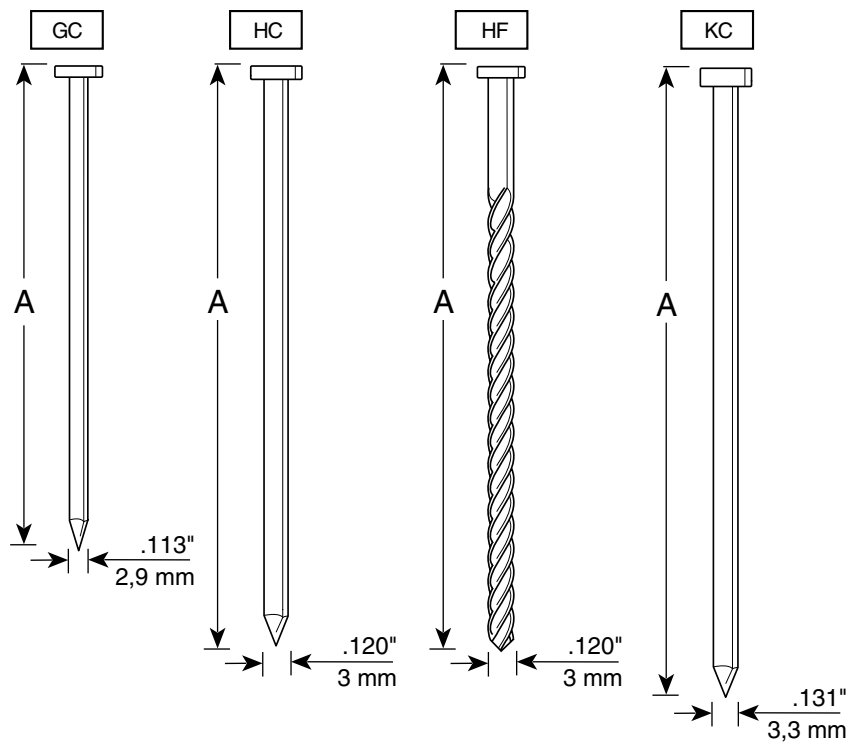
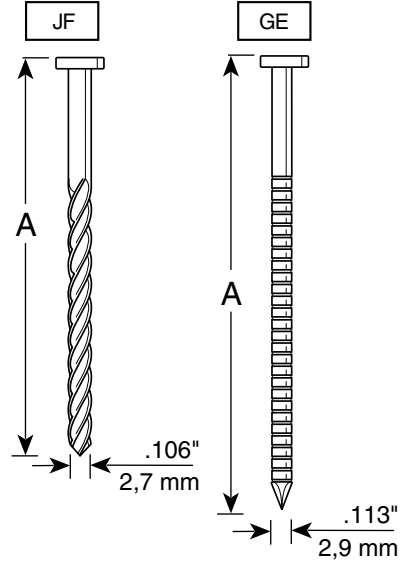

**FramePro® 602/652  
& 702XP/752XP FRH  
Series**

\* Rounded to nearest 5 mm  
\*\* FramePro 602/702XP only

			Specifications	Especificaciones	Specifications
			English	Español	Français
	FramePro FRH	A			
Code	inches	mm*			
GL**	2	50			
	2 3/8	60			
GD**	2	50			
	2 3/8	60			
HD	2 1/2	65			
	3	75			
HL	3	75			
	2 1/2	65			
KD	3	75			
	3 1/4	83			
	3 1/2	90			
MD	2 1/4	57			
	3	75			
	3 1/4	83			

**FramePro® 601/651  
& 701XP/751XP CH  
Series**

**Specifications**

**Especificaciones**

**Specifications**

**English**

**Español**

**Français**

Code	A	
	inches	mm
GE	2	50
	2 3/8	60
GC	2	50
	2 1/4	57
	2 3/8	60
HC	3	75
	3	75
	3	75
HE	3	75
	3	75
	3	75
HF	3	75
	3	75
	3	75
KC	3	75
	3 1/4	83
	3 1/2	90
MC	3	75
	3 1/4	83

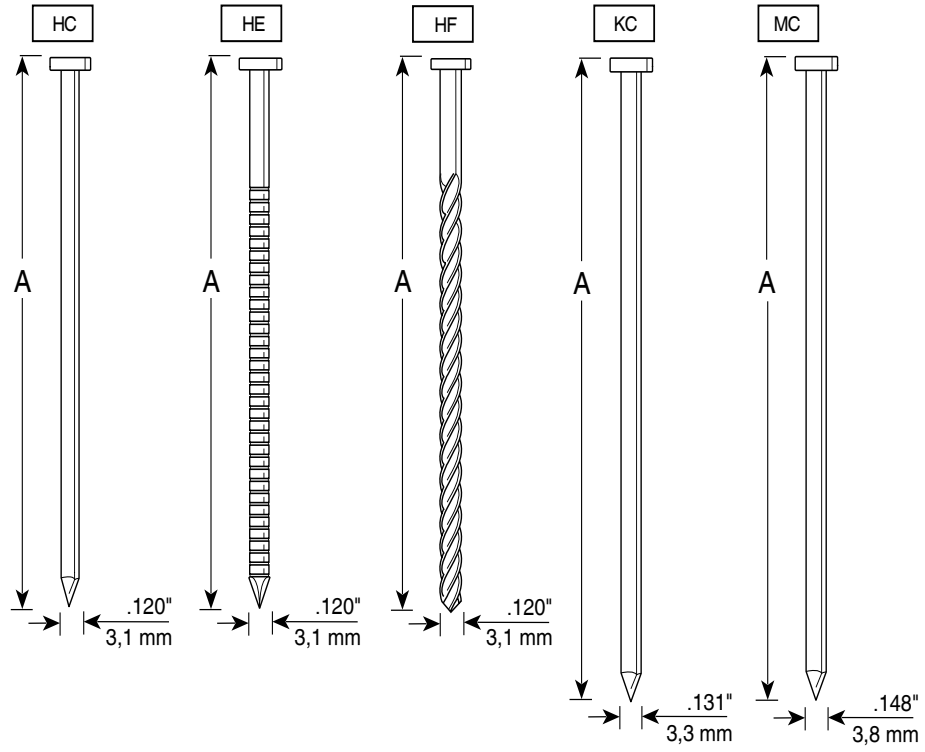
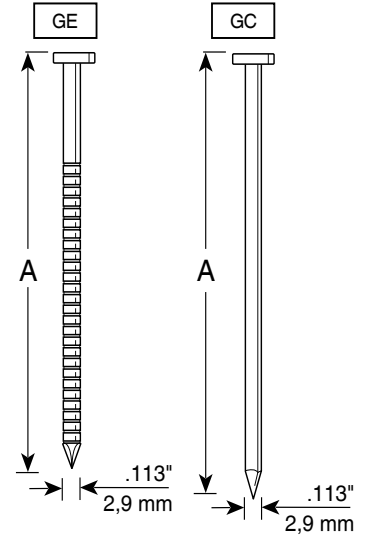

SN60MC	Specifications	Especificaciones	Specifications																
	English	Español	Français																
	<table border="1"> <thead> <tr> <th rowspan="2">Code</th> <th colspan="2">A</th> </tr> <tr> <th>inches</th> <th>mm</th> </tr> </thead> <tbody> <tr> <td>KJ</td> <td>1 1/2</td> <td>38</td> </tr> <tr> <td rowspan="2">MD</td> <td>1 1/2</td> <td>38</td> </tr> <tr> <td>2 1/2</td> <td>65</td> </tr> <tr> <td>NN</td> <td>2 1/2</td> <td>65</td> </tr> </tbody> </table>	Code	A		inches	mm	KJ	1 1/2	38	MD	1 1/2	38	2 1/2	65	NN	2 1/2	65		
Code	A																		
	inches	mm																	
KJ	1 1/2	38																	
MD	1 1/2	38																	
	2 1/2	65																	
NN	2 1/2	65																	

TECHNICAL SPECIFICATIONS	Specifications	Especificaciones	Specifications	
	English	Español	Français	
	SN70	SN60MC		
Minimum to maximum operating pressure	65–120 psi	4.5–8.3 bar	80–120 psi	5.5–8.3 bar
Air Consumption (60 cycles per minute)	9.67 scfm	273.8 liter	8.16scfm	231.2 liter
Air Inlet	3/8 in. NPT	3/8 in. NPT	3/8 in. NPT	3/8 in. NPT
Weight	9.7 lbs.	4.4 kg	7.7 lbs.	3.5 kg
Fastener Capacity	50-70	50-70	30	30
Tool size: Height	14.7 in.	373 mm	12 5/16 in.	312 mm
Tool size: Length	15.9 in.	404 mm	15 in.	381 mm
Tool size: Width: Main Body	4.5 in.	113 mm	4 3/8 in.	111 mm

ESPECIFICACIONES TECNICAS	SN70	SN60MC
Presión de operación mínima y máxima	65–120 psi	4.5–8.3 bar
Consumo de aire (60 ciclos por minuto)	9.67 scfm	273.8 liter
Entrada de aire	3/8 in. NPT	3/8 in. NPT
Peso	9.7 lbs.	4.4 kg
Capacidad de grapas por cargador	50-70	50-70
Tamaño de la herramienta: Altura	14.7 in.	373 mm
Tamaño de la herramienta: Longitud	15.9 in.	404 mm
Tamaño de la herramienta: Ancho (Cuerpo)	4.5 in.	113 mm

SPECIFICATIONS TECHNIQUES	SN70	SN60MC
Pression de travail min. et max.	4.5–8.3 bar	5.5–8.3 bar
Consommation d'air (60 cycles par minute)	273.8 liter	231.2 liter
Admission d'air	3/8 in. NPT	3/8 in. NPT
Poids	4.4 kg	3.5 kg
Capacité de projectiles par magasin	50-70	30
Dimensions de l'outil: hauteur	373 mm	312 mm
Dimensions de l'outil: longueur	404 mm	381 mm
Dimensions de l'outil: largeur: corps de l'appareil)	113 mm	111 mm

<b>Specifications</b>	<b>Especificaciones</b>	<b>Specifications</b>
<b>English</b>	<b>Español</b>	<b>Français</b>

TECHNICAL SPECIFICATIONS	FramePro® 601 & 701XP & 721		FramePro® 602 FRH & 702XP FRH Series**		FramePro® 651 & 751XP CH Series**		FramePro® 752XP FRH Series**	
Minimum to maximum operating pressure	70–120 psi	4.8–8.3 bar	70–120 psi	4.8–8.3 bar	70–120 psi	4.8–8.3 bar	70–120 psi	4.8–8.3 bar
Air Consumption (60 cycles per minute)	10 scfm	283.2 liter	10 scfm	283.2 liter	11 scfm	311.5 liter	11 scfm	311.5 liter
Air Inlet	3/8 in. NPT	3/8 in. NPT	3/8 in. NPT	3/8 in. NPT	3/8 in. NPT	3/8 in. NPT	3/8 in. NPT	3/8 in. NPT
Weight	8 lbs.	3.62 kg	8.4 lbs.	3.81 kg	8.4 lbs.	3.81 kg	8.7 lbs.	3.97 kg
Fastener Capacity	70	70	60	60	70	70	60	60
Tool size: Height	13 .25 in.	337 mm	13 .25 in.	337 mm	14 .25 in.	362 mm	14 .25 in.	362 mm
Tool size: Length	15 .13 in.	384 mm	20 in.	508 mm	15 .13 in.	384 mm	20 in.	508 mm
Tool size: Width: Main Body	4.17 in.	106 mm	4.17 in.	106 mm	4.17 in.	106 mm	4.17 in.	106 mm

ESPECIFICACIONES TECNICAS	FramePro® 601 & 701XP & 721		FramePro® 602 FRH & 702XP FRH Series**		FramePro® 651 & 751 CH Series**		FramePro® 752XP FRH Series**	
Presión de operación mínima y máxima	70–120 psi	4.8–8.3 bar	70–120 psi	4.8–8.3 bar	70–120 psi	4.8–8.3 bar	70–120 psi	4.8–8.3 bar
Consumo de aire (60 ciclos por minuto)	10 scfm	283.2 liter	10 scfm	283.2 liter	11 scfm	311.5 liter	11 scfm	311.5 liter
Entrada de aire	3/8 in. NPT	3/8 in. NPT	3/8 in. NPT	3/8 in. NPT	3/8 in. NPT	3/8 in. NPT	3/8 in. NPT	3/8 in. NPT
Peso	8 lbs.	3.62 kg	8.4 lbs.	3.81 kg	8.4 lbs.	3.81 kg	8.7 lbs.	3.97 kg
Capacidad de grapas por cargador	70	70	60	60	70	70	60	60
Tamaño de la herramienta: Altura	13 .25 in.	337 mm	13 .25 in.	337 mm	14 .25 in.	362 mm	14 .25 in.	362 mm
Tamaño de la herramienta: Longitud	15 .13 in.	384 mm	20 in.	508 mm	15 .13 in.	384 mm	20 in.	508 mm
Tamaño de la herramienta: Ancho (Cuerpo)	4.17 in.	106 mm	4.17 in.	106 mm	4.17 in.	106 mm	4.17 in.	106 mm

SPECIFICATIONS TECHNIQUES	FramePro® 601 & 701XP & 721		FramePro® 602 FRH & 702XP FRH Series**		FramePro® 651 & 751XP CH Series**		FramePro® 752XP FRH Series**	
Pression de travail min. et max.	70–120 psi	4.8–8.3 bar	70–120 psi	4.8–8.3 bar	70–120 psi	4.8–8.3 bar	70–120 psi	4.8–8.3 bar
Consommation d'air (60 cycles par minute)	10 scfm	283.2 liter	10 scfm	283.2 liter	11 scfm	311.5 liter	11 scfm	311.5 liter
Admission d'air	3/8 in. NPT	3/8 in. NPT	3/8 in. NPT	3/8 in. NPT	3/8 in. NPT	3/8 in. NPT	3/8 in. NPT	3/8 in. NPT
Poids	8 lbs.	3.62 kg	8.4 lbs.	3.81 kg	8.4 lbs.	3.81 kg	8.7 lbs.	3.97 kg
Capacité de projectiles par magasin	70	70	60	60	70	70	60	60
Dimensions de l'outil: hauteur	13 .25 in.	337 mm	13 .25 in.	337 mm	14 .25 in.	362 mm	14 .25 in.	362 mm
Dimensions de l'outil: longueur	15 .13 in.	384 mm	20 in.	508 mm	15 .13 in.	384 mm	20 in.	508 mm
Dimensions de l'outil: largeur: corps de l'appareil)	4.17 in.	106 mm	4.17 in.	106 mm	4.17 in.	106 mm	4.17 in.	106 mm

**\*\*REFERENCE**

CH Model Series	FRH Model Series	CH Model Series	FRH Model Series
FramePro® 601 FramePro® 701XP FramePro® 721	FramePro® 602 FramePro® 702XP	FramePro® 651 FramePro® 751XP	FramePro® 752XP

	<b>Options</b>	<b>Options</b>
	<b>English</b>	<b>Español</b>
		<b>Français</b>
<b>SN70</b> <b>FramePro® Series</b>	<ul style="list-style-type: none"> <li>● <b>RESTRICTIVE TRIGGER</b>— This feature is helpful when precise fastener placement is required.</li> </ul>	<ul style="list-style-type: none"> <li>● <b>GATILLO RESTRINGIDO</b>— Esta característica sirve de ayuda cuando se requiere una colocación del sujetador precisa.</li> </ul>
		<ul style="list-style-type: none"> <li>● <b>DECLÉNCHEMENT PAR GACHETTE</b>— Cette caractéristique s'avère utile quand un placement de projectiles précis s'impose.</li> </ul>

**FramePro® 600 & 700  
CH Series**



**SN60MC**

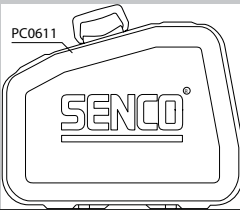

Options English	Opciones Español	Options Français
<p>● <b>CARRYING CASE</b> — A durable carrying case is available to help protect and prolong the life of the tool. The case can also be used to carry accessories and fasteners.</p>	<p>● <b>MALETIN PORTA HERRAMIENTA</b> — Un maletín durable esta disponible para ayudarle a proteger y prolongar la vida de su herramienta. El maletín puede también ser usado para llevar accesorios y sujetadores (clavos o grapas).</p>	<p>● <b>MALETTE DE TRANSPORT</b> — Une robuste malette est disponible pour protéger et prolonger la durée de vie de l'appareil. Elle peut également être utilisée pour le transport des accessoires et des projectiles.</p>
<p>● <b>HANGER</b>— Cap can be altered to attach a hanger. Use a 5/16"-18 UNC tap, and drill to a depth of approximately 1/2 in. Use a 5/16" x 3 1/8" long eyebolt.</p>	<p>● <b>COLGADERO O GANCHO</b>— La tapa puede ser modificada para adherirle un colgadero o gancho. Use una broca de 5/16" - 18 UNC Y barrene hasta una profundidad de aproximadamente 1/2" pulgada. Use un perno de argolla de 5/16" por 3 1/8" de largo.</p>	<p>● <b>SUSPENSION</b>— Le bouchon peut être modifié pour y adapter une suspension. Percer (13 maxi de profondeur) et tarauder (M16) à l'emplacement indiqué, pour y visser la suspension désirée.</p>
<p>● <b>CARRYING CASE</b> — A durable carrying case is available to help protect and prolong the life of the tool. The case can also be used to carry accessories and fasteners.</p>	<p>● <b>MALETIN PORTA HERRAMIENTA</b> — Un maletín durable esta disponible para ayudarle a proteger y prolongar la vida de su herramienta. El maletín puede también ser usado para llevar accesorios y sujetadores (clavos o grapas).</p>	<p>● <b>MALETTE DE TRANSPORT</b> — Une robuste malette est disponible pour protéger et prolonger la durée de vie de l'appareil. Elle peut également être utilisée pour le transport des accessoires et des projectiles.</p>

Accessories English	Accesorios Español	Accessoires Français
<p>SENCO offers a full line of accessories for your SENCO tools, including:</p> <ul style="list-style-type: none"> <li>● Air Compressors</li> <li>● Hose</li> <li>● Couplers</li> <li>● Fittings</li> <li>● Safety Glasses</li> <li>● Pressure Gauges</li> <li>● Lubricants</li> <li>● Regulators</li> <li>● Filters</li> </ul> <p>For more information or a complete illustrated catalogue of SENCO accessories, ask your representative for #MK336.</p>	<p>SENCO ofrece una línea completa de Accesorios para sus herramientas SENCO, incluyendo:</p> <ul style="list-style-type: none"> <li>● Compresores de Aire</li> <li>● Manguera</li> <li>● Conectores Rápidos</li> <li>● Conectores</li> <li>● Anteojos De Seguridad</li> <li>● Manómetros</li> <li>● Lubricantes</li> <li>● Reguladores</li> <li>● Filtros</li> </ul> <p>Para mas informacion ó un pour recevoir un catalogo completo ilustrado de los Accesorios SENCO, pregunte a su representante pour el numero #MK336.</p>	<p>SENCO offre une gamme étendue d'accessoires pour vos outils SENCO y compris :</p> <ul style="list-style-type: none"> <li>● Compresseurs</li> <li>● Tuyauterie flexible</li> <li>● Raccords</li> <li>● Lunettes de sécurité</li> <li>● Manomètres</li> <li>● Lubrifiants</li> <li>● Régulateurs</li> <li>● Filtres</li> </ul> <p>Pour plus d'informations ou pour recevoir un catalogue détaillé des accessoires proposés par SENCO, prenez contact avec votre représentant SENCO (référence catalogue : #MK336.).</p>

# Limited Warranty

## SENCO® Pneumatic, DuraSpin®, Cordless Tools & Compressors

Senco Products, Inc. ("SENCO") designs and constructs its products using the highest standards of material and workmanship. SENCO warrants to the original retail purchaser that the following products will be free from defects in material or workmanship for the warranty period specified below:

SENCO® XP Series-Red Cap	SENCO PRO Series	SENCO Compressors
Five years	One year	One year
SENCO® XP Series-Black Cap	SENCO DuraSpin®	SENCO Cordless
Two Years	One year	Two years
SENCO FP502	SENCO Reconditioned Products	Gas Cordless
Two Years	One Year	Two Years

During the warranty period (which begins on the purchase date), SENCO will repair or replace, at SENCO's option and expense, any product or part that is defective in materials or workmanship after examination by a SENCO Authorized Warranty Service Center, subject to the exceptions, exclusions and limitations described below. Any replacement product or part will carry a warranty for the balance of the warranty period applicable to the replaced product or part. A DATED SALES RECEIPT OR PROOF OF PURCHASE FROM THE ORIGINAL RETAIL PURCHASER IS REQUIRED TO MAKE A WARRANTY CLAIM. Product registration can be accomplished through on-line Product Registration at [www.senco.com](http://www.senco.com) or by completing and returning the postage paid product registration form included with your Operator's manual/parts chart information, found inside the product carton. To make a warranty claim, you must return the product, with proper receipt/proof of purchase and return transportation charges prepaid, to a SENCO Authorized Warranty Service Center. A list of SENCO Authorized Warranty Service Centers can be found at [www.senco.com](http://www.senco.com) or by calling 1-800-543-4596 toll free. SENCO will perform its obligations under this warranty, within a reasonable time after approval of the warranty claim.

### Wheelbarrow Compressors:

1. Subject to the exceptions, exclusions and limitations described below, SENCO warrants that the compressor pump will be free from defects in materials and workmanship for two years after the purchase date.
2. Defective parts of the compressor pump not subject to normal wear and tear will be repaired or replaced, at SENCO's option, during the two year warranty period. If SENCO determines that repair or replacement is not feasible, SENCO will refund the purchase price less reasonable depreciation based on actual use.

### SENCO Cordless:

1. Subject to the exceptions, exclusions and limitations described below, SENCO warrants that the SENCO Cordless tool will be free from defects in materials and workmanship for two years after the purchase date.
2. Subject to the exceptions, exclusions and limitations described below, SENCO warrants that the batteries and chargers used with SENCO Cordless tools will be free from defects in material and workmanship for one year after the purchase date.

### WARRANTY EXCLUSIONS

The following warranty exclusions apply:

1. Normal wear parts are not covered under this warranty. Normal wear parts include, for example, isolators, drive belts, air filters, rubber o-rings, seals, driver blades, piston stops, piston/driver assembly, and fuel stems.
2. This warranty does not cover parts damaged due to normal wear, misapplication, misuse, accidents, operation at other than recommended speeds or voltage (electric units only), improper storage, or damage resulting during shipping.
3. Products used in production/industrial applications as defined by SENCO are excluded from this warranty.
4. Labor charges or loss or damage resulting from improper operation, maintenance or repairs are not covered by this warranty.
5. SENCO does not warrant the Wheelbarrow Compressor Engine/Motor, but the Compressor Engine/Motor may be covered under a warranty offered by its manufacturer.

### GENERAL WARRANTY CONDITIONS

This warranty will be honored, only if:

- A. Clean, dry, regulated compressed air has been used, at air pressure not exceeding the maximum indicated on the tool casting;
- B. No evidence of abuse, abnormal conditions, accident, neglect, misuse or improper modifications or storage of the product; and
- C. No Deviation from operating instructions, specifications, and maintenance schedules exists (read Operator Manual for use, specifications, and maintenance instructions).

THIS WARRANTY IS THE ONLY WARRANTY ON THE PRODUCT, AND SENCO DISCLAIMS ALL OTHER WARRANTIES. ANY IMPLIED WARRANTIES WILL BE LIMITED IN DURATION TO THE APPLICABLE WARRANTY PERIOD SPECIFIED ABOVE. SOME STATES DO NOT ALLOW LIMITATIONS ON HOW LONG AN IMPLIED WARRANTY LASTS, SO THE ABOVE LIMITATION MAY NOT APPLY TO YOU. YOUR REMEDIES ARE SOLELY AND EXCLUSIVELY AS STATED ABOVE. SENCO SHALL IN NO EVENT BE LIABLE FOR INCIDENTAL, CONSEQUENTIAL, INDIRECT, OR SPECIAL DAMAGES. SOME STATES DO NOT ALLOW THE EXCLUSION OR LIMITATION OF INCIDENTAL OR CONSEQUENTIAL DAMAGES, SO THE ABOVE LIMITATION OR EXCLUSION MAY NOT APPLY TO YOU. IN NO EVENT, WHETHER AS A RESULT OF A BREACH OF CONTRACT, WARRANTY, TORT (INCLUDING NEGLIGENCE) OR OTHERWISE, SHALL SENCO'S LIABILITY EXCEED THE PRICE OF THE PRODUCT WHICH HAS GIVEN RISE TO THE CLAIM OR LIABILITY. ANY LIABILITY CONNECTED WITH THE USE OF THIS PRODUCT SHALL TERMINATE UPON THE EXPIRATION OF THE WARRANTY PERIOD SPECIFIED ABOVE. NO EMPLOYEE OR REPRESENTATIVE OF SENCO OR ANY DISTRIBUTOR OR DEALER IS AUTHORIZED TO MAKE ANY CHANGE OR MODIFICATION TO THIS WARRANTY.

This warranty gives you specific legal rights, and you may also have other rights which vary from state to state.

### REPLACEMENT OF TOOL DUE TO NATURAL DISASTER

SENCO will replace any tool destroyed by an Act of God such as flood, earthquake, hurricane or other disaster resulting only from the forces of nature. Such a claim will be honored provided that such original retail purchaser had previously submitted a completed warranty registration card for the tool, and then submits proof of ownership and an acceptable statement describing such Act of God documented by an insurance carrier, police department, or other official governmental source. To obtain instructions for filing a claim call 1-800-543-4596.

### CUSTOMER SATISFACTION

One hundred percent customer satisfaction is our #1 goal. If for any reason the product does not perform to the original purchaser's satisfaction, it can be returned to the place of purchase **within thirty days** with dated sales receipt for a full refund of the purchase price.

©2006, 2008 by SENCO PRODUCTS, INC.

CINCINNATI, OHIO 45244-1611 USA

[www.senco.com](http://www.senco.com)

012108