

# BOSCH

January 2000  
INDUSTRIAL

1/2" DRILL  
Model 0601048639

## 1033VSR

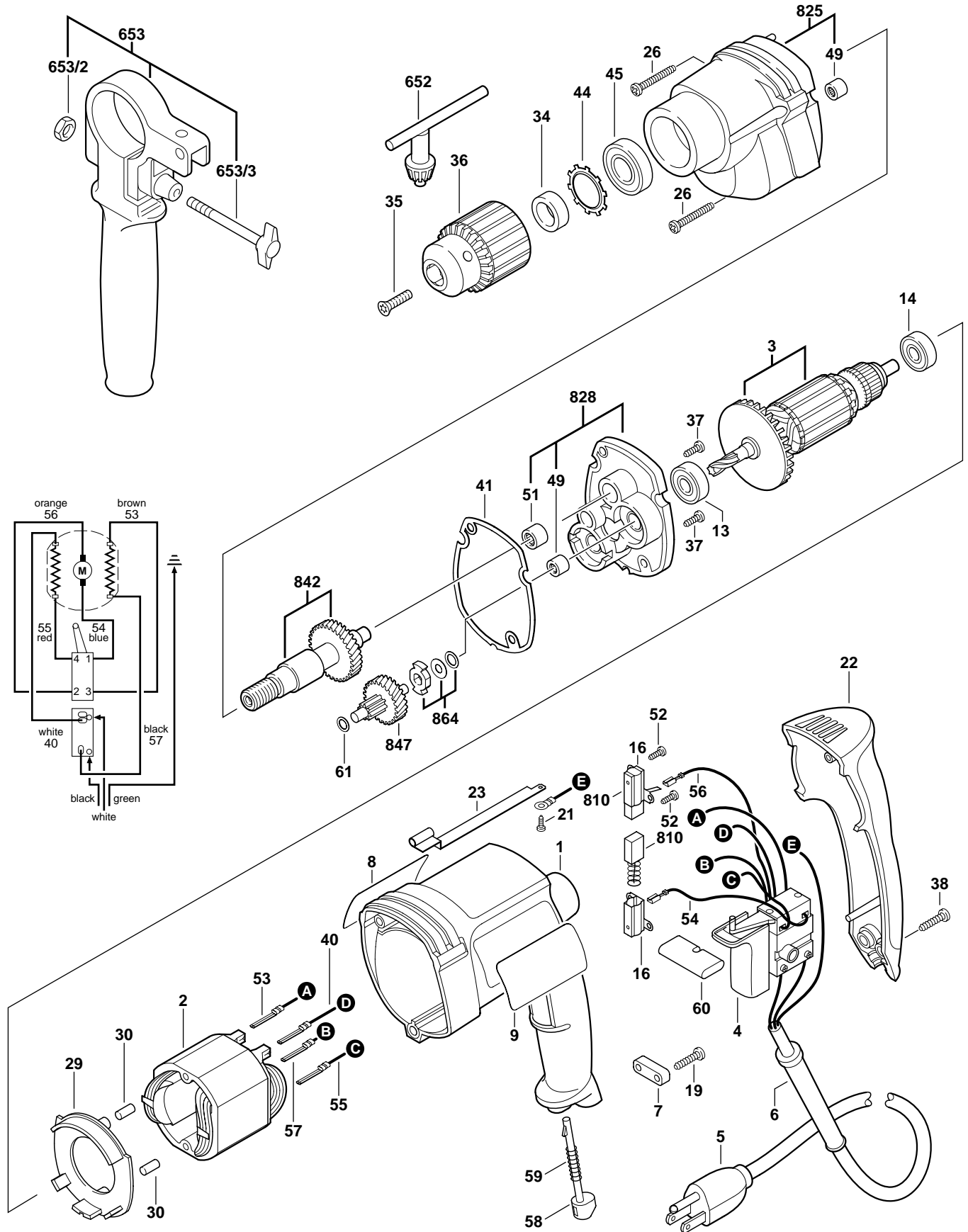

# 1033VSR 1/2" DRILL

Pos.	Part Number	Description {Qty.}	F/C	Pos.	Part Number	Description {Qty.}	F/C
1	2 610 998 100	Motor Housing	71	45	2 610 968 044	Ball Bearing	56
2	2 610 998 129	Field	22	49	2 600 914 010	Needle Bearing {2}	56
3	2 610 998 112	Armature w/Fan	AW	51	1 600 910 018	Needle Bearing	56
4	2 610 998 107	Switch VSR	17	52	2 910 611 405	Screw {4}	89
5	2 610 998 127	Cord	11	53	2 610 998 133	Cable	10
6	2 600 703 013	Strain Relief	11	54	2 610 998 134	Cable	10
7	2 601 035 001	Cord Clamp	89	55	2 610 998 135	Cable	10
8	2 610 998 435	Nameplate	9	56	2 610 998 136	Cable	10
9	2 610 998 418	Lable "Bosch"	9	57	2 610 998 137	Cable	10
13	2 610 351 861	Ball Bearing	60	58	2 610 998 114	Lock-On Lever	64
14	1 900 905 018	Ball Bearing	61	59	2 610 998 116	Spring	27
16	2 604 337 003	Brush Holder {2}	25	60	2 610 998 113	Reversing Lever	64
19	2 610 315 386	Screw {2}	89	61	2 600 100 607	Shim 0.3mm	65
21	2 610 907 525	Screw	89	+ 651	2 610 304 790	Key Holder	9
22	2 610 998 102	Handle Cover	74	652	2 610 348 635	Chuck Key	91
23	2 610 998 118	Grounding Strap	10	653	2 602 025 094	Handle Assembly	74
26	2 910 615 082	Screw {3}	89			w/pos. 653/2, 653/3	
29	2 610 998 115	Baffle	24	653/2	2 915 011 007	Nut	89
30	3 602 391 503	Rubber Buffer {2}	66	653/3	1 613 480 007	Wing Screw	89
34	2 610 998 132	Spacer	82	810	2 604 321 914	Brush Set	26
35	2 610 346 444	Reversing Screw LH	85	825	2 610 998 144	Gear Housing Assembly	72
36	2 610 906 123	1/2" Keyed Chuck	91			w/pos. 49	
37	2 914 411 045	Screw {2}	89	828	2 610 998 153	Intermediate Plate Assy.	38
38	2 910 615 022	Screw {3}	89			w/pos. 49, 51	
40	2 610 998 138	Cable	10	842	2 610 907 368	Spindle w/Gear Assembly	32
41	2 610 998 117	Gasket	79	847	2 610 998 147	Intermediate Gear Assy.	31
44	2 610 998 128	Retaining Ring	89	864	2 610 907 408	Eccentric w/Washer Assy.	34

## Service Notes:

<b>BOSCH</b> July 2001 <b>TECHNICAL BULLETIN</b>	<b>Section 3 - Drills / Drivers</b>	model(s) affected
	"Recall Notification"	<b>Various</b>

To: All Authorized and Factory Service Centers,  
Field Sales and Internal Support Personnel

Re: Recall Notification for models 1011VSR (060 1044 639)      1031VSR (060 1047 639)  
1012VSR (060 1044 739)      1032VSR (060 1047 739)  
1013VSR (060 1045 639)      1033VSR (060 1048 639)  
1014VSR (060 1044 739)      1034VSR (060 1049 639)  
1030VSR (060 1046 639)      1035VSR (060 1048 739)

Please insert this bulletin into the "Technical Bulletins" section of your Bosch Parts Manual, only after making any additions or notes to your Illustrated Parts List(s).

The above listed models were the subject of a voluntary recall issued in September of 2000. Efforts to recover all affected tools must continue indefinitely. Please do not repair or return to the customer any of the models listed above that have manufacturing date codes **R081 through R088**. Upon receipt of an affected tool, please call 877-678-1963 (toll free) for tool replacement instructions.

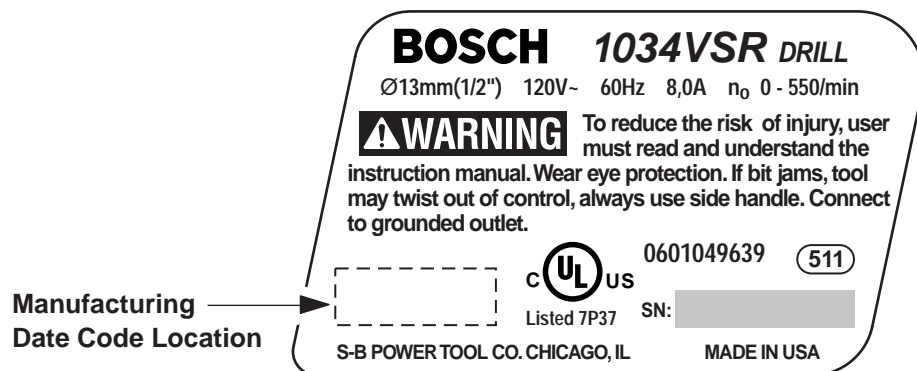

All questions should be directed to your Authorized Service Manager.

Product Service Department