

SENCO®

FinishPro® 42XP

Operating Instructions
Instrucciones de Operacion
Mode d'Emploi



Senco Products, Inc.
8485 Broadwell Road
Cincinnati, Ohio 45244

Questions? Comments?
call SENCO's toll-free Action-line: 1-800-543-4596
or e-mail: toolprof@senco.com

www.senco.com

© 2006 by Senco Products, Inc.



Warnings for the safe use of this tool are included in this manual.

Los avisos para el uso seguro de esta herramienta están incluidos en este manual.



Les consignes pour l'utilisation en toute sécurité de cet outil se trouvent dans ce manuel.

NFD84G Issued Dec. 4, 2006

| English | Espanol | Francais | |
|-------------------|-------------------|------------------------|---|
| TABLE OF CONTENTS | TABLA DE MATERIAS | TABLE DES MATIERES | |
| Tool Use | 1 | Utilisation de l'outil | 1 |
| Maintenance | 5 | Entretien | 5 |
| Troubleshooting | 6 | Dépannage | 6 |
| Specifications | 6 | Spécifications | 6 |
| Options | 7 | Options | 7 |
| Accessories | 7 | Accessoires | 7 |

| EMPLOYER'S RESPONSIBILITIES | RESPONSABILIDADES DEL EMPLEADOR | RESPONSABILITÉS DE L'EMPLOYEUR |
|--|---|---|
| Employer must enforce compliance with the safety warnings and all other instructions which accompany this tool as shipped from the manufacturer. | El empleador debe hacer cumplir las advertencias de seguridad y todas las otras instrucciones que acompañan a esta herramienta como se la despacha desde el fabricante. | L'employeur doit faire appliquer les consignes de sécurité et toutes les autres instructions qui accompagnent cet outil tel qu'il est livré par son constructeur. |
| Keep this manual available for use by all people assigned to the use of this tool. | Mantenga este manual disponible para que lo usen todas las personas destinadas a hacer uso de esta herramienta. | Ayez ce manuel à la disposition de toutes les personnes chargées d'utiliser cet outil. |
| For personal safety and proper operation of this tool, read and understand all of these instructions carefully. | Por razones de seguridad personal y la adecuada operación de esta herramienta, lea y comprenda todas estas instrucciones cuidadosamente. | Pour assurer la sécurité personnelle et le bon emploi de cet outil, lisez et assimilez soigneusement toutes ces instructions. |

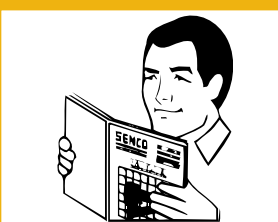
| Tool Use | Uso de la Herramienta | Utilisation de l'Outil |
|----------|-----------------------|------------------------|
|----------|-----------------------|------------------------|

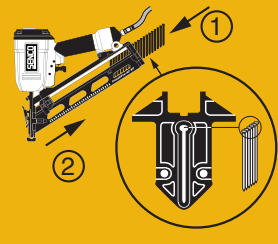
| English | Espanol | Francais |
|--|--|---|
|  <ul style="list-style-type: none"> ● Read and understand "SAFETY INSTRUCTIONS" manual shipped with this tool before using tool. | <ul style="list-style-type: none"> ● Antes de usar la herramienta lea y comprenda el manual "INSTRUCCIONES DE SEGURIDAD" despachado con ella. | <ul style="list-style-type: none"> ● Lisez et assimilez le manuel "INSTRUCTIONS DE SÉCURITÉ" livré avec cet outil avant de l'utiliser. |
|  <ul style="list-style-type: none"> ● Keep tool pointed away from yourself and others and connect air to tool. | <ul style="list-style-type: none"> ● Mantenga la herramienta apuntando en dirección opuesta de usted y de otros y conecte el aire a la manguera. | <ul style="list-style-type: none"> ● Maintenez l'outil pointé à l'écart d'autres personnes et de vous-même et raccordez l'air à l'outil. |
|  <ul style="list-style-type: none"> ● To Load: Insert strip of nails into rear of magazine. Use only genuine SENCO fasteners. Do not load with workpiece contact (safety element) or trigger depressed. Pull feeder shoe back. | <ul style="list-style-type: none"> ● Para cargar: Inserte la tira de clavos en la parte de atrás del área de almacenamiento. Use solamente sujetadores SENCO auténticos. No cargue con el disparo o la seguridad oprimidos. Tire la zapata del alimentador. | <ul style="list-style-type: none"> ● Pour charger : Introduisez une bande de clous dans la partie arrière du magasin. Utilisez uniquement les clous d'origine SENCO. Veillez à ne pas appuyer sur le palpeur de sécurité ou sur la détente quand vous chargez. Tirez le poussoir en arrière. |

English

Español

Français

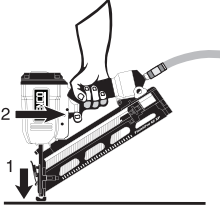

- With a Contact-Actuation (Dual-Action) trigger, nails can be driven two ways:
 - a) Position workpiece contact (safety element) against work surface and pull trigger... "Trigger Fire".

b) To drive a nail, pull trigger and push workpiece contact (safety element) against work surface. Each time the workpiece contact is pushed against the work surface a nail will be driven. This "bottom-fire" mode of operation is preferred when high production, rapid fastener placement is desired.

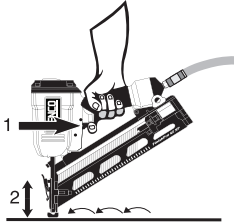

- Las herramientas con gatillo de acción doble pueden ser disparadas de dos maneras:
 - a) Oprima el seguro contra la superficie de trabajo y apriete el gatillo... Disparo de gatillo.
 - b) Para impulsar un clavo, oprima el disparador y deprima el elemento de seguridad contra la superficie de trabajo. Cada vez que deprima el elemento de seguridad contra la superficie de trabajo, impulsará un clavo. Este modo de operación de "disparo inferior" o "por rebote" es el preferido cuando se desea alta productividad y rápida colocación del clavo.

- Les appareils équipés de déclenchement "au touché / par gâchette" peuvent être utilisés de 2 façons différentes :
 - a) Déclenchement par "gâchette": Appliquer le palpeur de sécurité de l'appareil à l'endroit désiré et activer la gâchette.
 - b) Pour planter un clou, tirez sur la détente et poussez l'élément de sécurité contre la surface de travail. Chaque fois que l'élément de sécurité est poussé contre la surface de travail un clou est planté. Le mode de fonctionnement en "tir continu" est préférable si vous désirez placer des attaches rapidement avec forte productivité.

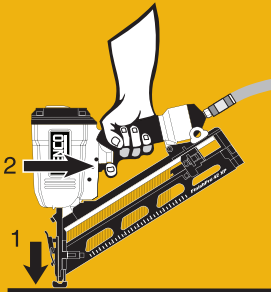

- With a Sequential (Restrictive) trigger, nails can only be driven one way. First depress workpiece contact (safety element) against work surface then pull trigger. This feature is helpful when precise fastener placement is required.
- Read the "Customer Satisfaction and Safety Reminder" (CSSR) in the tool and fastener boxes for safety information regarding the Contact-Actuation (Dual Action) and Sequential (Restrictive) triggers. Under certain conditions, the Sequential trigger may reduce the possibility of injury to you or to others working with you.

- Las herramientas con "Gatillo Restringido" solamente se pueden disparar con el gatillo. Primero apriete el elemento de seguridad contra la superficie de trabajo y después tire del gatillo. Esta característica es útil cuando se requiere precisión en la colocación de los sujetadores.
- Lea el "Recordatorio de Seguridad y Satisfacción del Cliente" (CSSR) en las cajas de sujetadores y de las herramientas para información sobre seguridad de los Gatillos Restringido y de Acción Dual. Bajo ciertas condiciones, el Gatillo Restringido puede reducir la posibilidad de heridas a su persona o a otros que trabajen con usted.

- Avec une gâchette "restrictive", les clous ne peuvent être tirés que dans une seule direction. Appuyer d'abord le palpeur de sécurité sur la surface de travail, puis tirer sur la gâchette. Cette fonction est utile pour un placement précis de projectiles.
- Lire le "Rappel de Sécurité et Satisfaction du Client" (CSSR) dans les boîtes à outils et fixations pour les informations de sécurité concernant les Détonnes à Double Action et à Restriction. Dans certaines circonstances, la Détonne à Restriction peut réduire la possibilité de se blesser ou de blesser d'autres personnes.

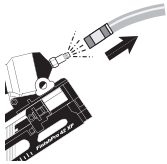

- Should a nail jam occur, disconnect air supply.

- Si se produce un altascamiento de un clavo, desconecte el suministro de aire.

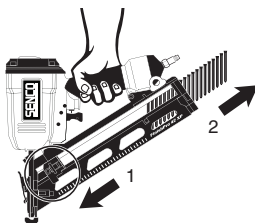

- Au cas où il se produirait un coincage de clous, coupez l'alimentation en air.





- Release the feeder shoe and slide it forward. Remove fasteners from the tool.

- Suelte el alimentador y deslícelo hacia adelante. Retire los sujetadores de la herramienta.

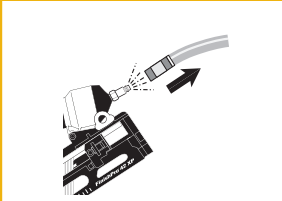
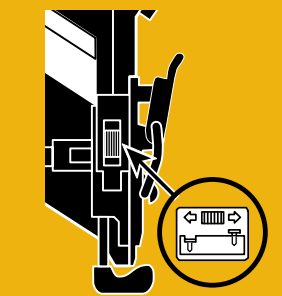
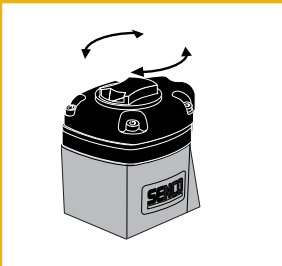
- Relâchez le poussoir et faites le glisser vers l'avant. Enlevez les projectiles.

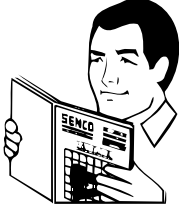
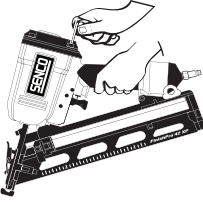
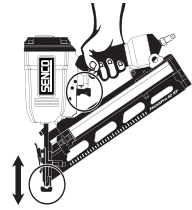
| | | Tool Use | Uso de la Herramienta | Utilisation de l'Outil |
|---|---|--|---|------------------------|
| | | English | Espanol | Francais |
|  | <ul style="list-style-type: none"> ● Release E-Z Clear latch and open door. Remove jammed fastener. Close door and latch. | <ul style="list-style-type: none"> ● Suelte el pestillo de alivio fácil (E-Z) y abra la puerta. Remueva el sujetador atascado. Cierre la puerta con pestillo. | <ul style="list-style-type: none"> ● Relâchez le loquet transparent "E-Z" et ouvrez le volet de front. Enlevez le clou coincé. Fermez le volet de front et le loquet. | |
|  | <ul style="list-style-type: none"> ● A No-Mar Pad (HF0079) can be added to the bottom of the workpiece contact (safety element) in an effort to help prevent scuffs or damage to the work surface. This pad is marked to indicate the exit point of the nail, making alignment easier. | <ul style="list-style-type: none"> ● Un cojinete "No-Mar" (HF0079) puede ser agregado debajo del elemento de contacto con el trabajo (seguro) en un esfuerzo para ayudar a prevenir marcas o daños a la superficie de trabajo. El cojinete esta marcado para indicar el punto de salida del clavo, haciendo mas fácil su alineación. | <ul style="list-style-type: none"> ● Une protection (HF0079) peut être ajoutée à la base de l'élément de contact dans le but d'éviter de marquer ou endommager la surface du produit cloué. Un repère figure sur cette protection, indiquant le sens de sortie du clou, pour en faciliter l'alignement lors de la mise en place. | |
|  | <ul style="list-style-type: none"> ● To adjust the depth of the fastener drive, first disconnect the air supply. | <ul style="list-style-type: none"> ● Para ajustar la profundidad de clavo o engrapado, debe primero desconectar el aire. | <ul style="list-style-type: none"> ● Pour ajuster la profondeur à laquelle le clou est enfoncé, déconnecter tout d'abord l'appareil de la source d'air comprimé. | |
|  | <ul style="list-style-type: none"> ● Using the thumb or index finger, rotate wheel (located on side of guide body) to adjust the workpiece contact (safety element) to achieve desired depth. Adjustments are in half-turn increments. Warning: Do not extend the workpiece contact 1/4" beyond the shortest setting. This could disengage the workpiece contact and render the tool inoperable. | <ul style="list-style-type: none"> ● Usando el dedo pulgar o el dedo indice, rote la manivela (localizada a un lado de la placa de nariz) para ajustar el seguro a la profundidad deseada. Ajustes deben incrementarse cada media vuelta. No sobrepase el seguro mas de 1/4" de pulga de la ultima marca. Esto causaría el desenganche del seguro haciendo la herramienta inoperable. | <ul style="list-style-type: none"> ● A l'aide du pouce ou de l'index, faire tourner la molette (située sur le cote du front) pour ajuster la position du palpeur de sécurité. Paliers de réglages par 1/2 tour. Ne pas dépasser 1/4" (6,35 mm) de sortie du palpeur par rapport a la position la plus courte. Cela pourrait le désengager et rendre l'appareil inutilisable. | |
|  | <ul style="list-style-type: none"> ● To adjust the direction of the exhaust air, turn the exhaust deflector to the desired location. | <ul style="list-style-type: none"> ● Mantenga la herramienta apuntada en la dirección opuesta de usted y de otros y conecte el aire a la manguera. | <ul style="list-style-type: none"> ● Pour changer la direction de l'échappement d'air, faire pivoter le déflecteur jusqu'à la position souhaitée. | |

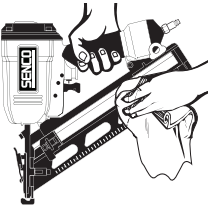
| | Maintenance | Mantenimiento | Entretien |
|---|---|--|--|
| | English | Espanol | Francais |
|  | <ul style="list-style-type: none"> ● Read and understand "SAFETY INSTRUCTIONS" manual shipped with this tool before using tool. | <ul style="list-style-type: none"> ● Antes de usar la herramienta lea y comprenda el manual "INSTRUCCIONES DE SEGURIDAD" despachado con ella. | <ul style="list-style-type: none"> ● Lisez et assimilez le manuel "INSTRUCTIONS DE SÉCURITÉ" livré avec cet outil avant de l'utiliser. |
|  | <ul style="list-style-type: none"> ● All screws should be kept tight. Loose screws result in unsafe operation and parts breakage. | <ul style="list-style-type: none"> ● Todos los tornillos tienen que mantenerse apretados. Los tornillos sueltos pueden producir una operación no segura y quebraduras de partes. | <ul style="list-style-type: none"> ● Toutes les vis doivent être maintenues serrées à fond. Les vis desserrées entraînent un manque de sûreté du fonctionnement et la rupture de pièces. |
|  | <ul style="list-style-type: none"> ● With tool disconnected, make daily inspection to assure free movement of workpiece contact (safety element) and trigger. Do not use tool if workpiece contact or trigger sticks or binds. | <ul style="list-style-type: none"> ● Con la herramienta desconectada, haga inspecciones diarias para asegurar el movimiento libre del seguro y del gatillo. No use la herramienta si el seguro o el gatillo se pegan o se atorán. | <ul style="list-style-type: none"> ● L'outil étant séparé de l'alimentation en air, effectuez une inspection journalière pour assurer le libre mouvement du palpeur de sécurité et de la détente. N'utilisez pas l'outil si le palpeur de sécurité ou la détente colle ou se coince. |
|  | <ul style="list-style-type: none"> ● Routine lubrication is not necessary. Do not oil. | <ul style="list-style-type: none"> ● La lubricación de rutina no es necesaria. No aceite. | <ul style="list-style-type: none"> ● La lubrification de routine n'est pas nécessaire. N'huilez pas. |
|  | <ul style="list-style-type: none"> ● Wipe tool clean daily and inspect for wear. Use non-flammable cleaning solutions only if necessary-DO NOT SOAK. Caution: Such solutions may damage O-rings and other tool parts. | <ul style="list-style-type: none"> ● Solamente si es necesario use soluciones para limpieza no inflamables -NO LA REMOJE. Precaución: Tales soluciones pueden dañar los empaques y otras partes de la herramienta. | <ul style="list-style-type: none"> ● Nettoyez l'outil chaque jour à l'aide d'un chiffon et inspectez-le pour déceler une éventuelle usure. Utilisez uniquement des solvants non inflammables en cas de nécessité-NE LE FAITES PAS TREMPER ! Attention : De tels produits peuvent endommager les joints et autres pièces de l'appareil. |

Troubleshooting

Identificación de Fallas

Dépannage

English

Espanol

Francais

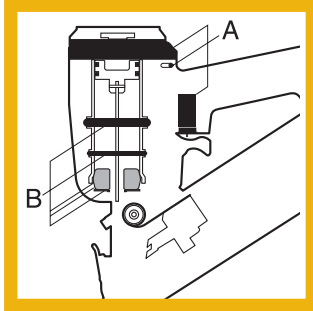

WARNING

Repairs other than those described here should be performed only by trained, qualified personnel. Contact SENCO for information at 1-800-543-4596.

- Read and understand "SAFETY INSTRUCTIONS" manual shipped with this tool before using tool.

ALERTA

Las reparaciones, fuera de aquellas descritas aquí, deben de ser llevadas a cabo solamente por personal entrenado y calificado. Póngase en contacto con SENCO para información 1-800-543-4596.

- Antes de usar la herramienta lea y comprenda el manual "INSTRUCCIONES DE SEGURIDAD" despachado con ella.

AVERTISSEMENT

Les réparations autres que celles décrites ici doivent être réalisées uniquement par du personnel qualifié ayant reçu la formation appropriée. Pour toute information, prenez contact avec SENCO par téléphone en appelant Le Distributeur agréé.

- Lisez et assimilez le manuel "INSTRUCTIONS DE SÉCURITÉ" livré avec cet outil avant de l'utiliser.

SYMPTOM

Air leak near top of tool / Sluggish operation

SOLUTION

Verify air supply / tighten screws or install Parts Kit A (YK0361).

SÍNTOMA

El aire se escapa cerca de la parte superior de la herramienta / Operación lenta.

SOLUCIÓN

Apriete los tornillos / Verifique el suministro de aire o instale el Juego de Partes A (YK0361).

SYMPTÔME

Fuite d'air près du sommet de l'outil / fonctionnement lent.

SOLUTION

Serrez les vis à fond / vérifiez l'alimentation en air ou remplacez les pièces portant la lettre "A". (YK0361)

SYMPTOM

Air leak near bottom of tool / Poor return.

SOLUTION

Clean tool / tighten screws or install Parts Kit B (YK0362).

SÍNTOMA

El aire se fuga cerca de la parte inferior de la herramienta / Mal retorno.

SOLUCIÓN

Apriete los tornillos / Limpié la herramienta o instale el Juego de Partes B (YK0362).

SYMPTÔME

Fuite d'air près de la base de l'outil / retour inadéquat.

SOLUTION

Serrez les vis à fond / nettoyez l'outil ou remplacez les pièces portant la lettre "B" (YK0362)

SYMPTOM

Other problems.

SOLUTION

Contact SENCO.

SÍNTOMA

Otros problemas.

SOLUCIÓN

Póngase en contacto con SENCO.

SYMPTÔME

Autres problèmes.

SOLUTION

Prenez contact avec SENCO.

Specifications

Especificaciones

Specifications

English

Espanol

Francais

| Code | A | |
|------|--------|----|
| | inches | mm |
| DA15 | 1 1/4 | 32 |
| DA17 | 1 1/2 | 38 |
| DA19 | 1 3/4 | 44 |
| DA21 | 2 | 50 |
| DA23 | 2 1/4 | 57 |
| DA25 | 2 1/2 | 65 |

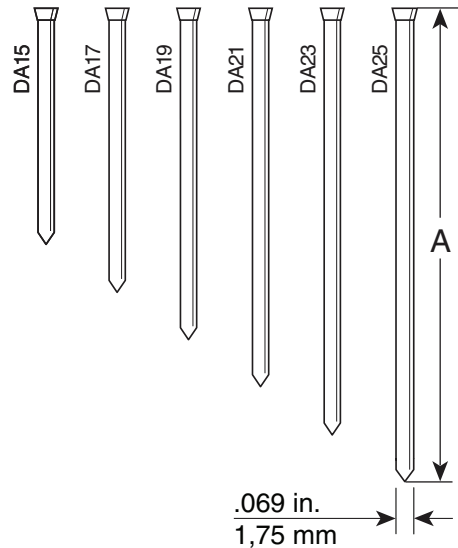

| English TECHNICAL SPECIFICATIONS | | Espanol ESPECIFICACIONES TECNICAS | | Francais SPECIFICATIONS TECHNIQUES | |
|--|-------------|--|-------------|---|-------------|
| Minimum to maximum operating pressure | 70–120 psi | Presión de operación mínima y máxima | 4.8–8.3 bar | Pression de travail min. et max. | 4.8–8.3 bar |
| Air Consumption (60 cycles per minute) | 3.87 scfm | Consumo de aire (60 ciclos por minuto) | 109.6 liter | Consommation d'air (60 cycles par minute) | 109.6 liter |
| Air Inlet | 1/4 in. NPT | Entrada de aire | 1/4 in. NPT | Admission d'air | 1/4 in. NPT |
| Maximum Speed (cycles per second) | 4 | Velocidad máxima (ciclos por segundo) | 4 | Vitesse maximum (cycles par seconde) | 4 |
| Weight | 4.7 lbs. | Peso | 2.1 kg | Poids | 2.1 kg |
| Fastener Capacity | 104 | Capacidad de grapas por cargador | 104 | Capacité de projectiles par magasin | 104 |
| Tool size: Height | 11 1/4 in. | Tamaño de la herramienta: Altura | 286 mm | Dimensions de l'outil: hauteur | 286 mm |
| Tool size: Length | 13 in. | Tamaño de la herramienta: Longitud | 330 mm | Dimensions de l'outil: longueur | 330 mm |
| Tool size: Width: Main Body | 3 1/2 in. | Tamaño de la herramienta: Ancho (Cuerpo) | 89 mm | Dimensions de l'outil: largeur: corps de l'appareil | 89 mm |

| Accessories | | |
|---|--|---|
| English | Espanol | Francais |
| <p>SENCO offers a full line of accessories for your SENCO tools, including:</p> <ul style="list-style-type: none"> ● Air Compressors ● Hose ● Couplers ● Fittings ● Safety Glasses ● Pressure Gauges ● Lubricants ● Regulators ● Filters <p>For more information or a complete illustrated catalogue of SENCO accessories, ask your representative for #MK336.</p> | <p>SENCO ofrece una línea completa de Accesorios para sus herramientas SENCO, incluyendo:</p> <ul style="list-style-type: none"> ● Compresores de Aire ● Manguera ● Conectores Rápidos ● Conectores ● Anteojos De Seguridad ● Manómetros ● Lubricantes ● Reguladores ● Filtros <p>Para mas informacion ó un pour recevoir un catalogo completo ilustrado de los Accesorios SENCO, pregunte a su representante para el numero MK336.</p> | <p>SENCO offre une gamme étendue d'accessoires pour vos outils SENCO y compris :</p> <ul style="list-style-type: none"> ● Compresseurs ● Tuyauterie flexible ● Raccords ● Lunettes de sécurité ● Manomètres ● Lubrifiants ● Régulateurs ● Filtres <p>Pour plus d'informations ou pour recevoir un catalogue détaillé des accessoires proposés par SENCO, prenez contact avec votre représentant SENCO (référence catalogue : #MK336).</p> |
| Options | | |
| English | Espanol | Francais |
| <ul style="list-style-type: none"> ● SEQUENTIAL (RESTRICTIVE) TRIGGER— This feature is helpful when precise fastener placement is required. | <ul style="list-style-type: none"> ● GATILLO RESTRINGIDO— Esta característica sirve de ayuda cuando se requiere una colocación del sujetador precisa. | <ul style="list-style-type: none"> ● DECLÉNCHEMENT PAR GACHETTE— Cette caractéristique s'avère utile quand un placement de projectiles précis s'impose. |

Limited Warranty SENCO® Pneumatic, DuraSpin®, Cordless Tools & Compressors

Senco Products, Inc. ("SENCO") designs and constructs its products using the highest standards of material and workmanship. SENCO warrants to the original retail purchaser that the following products will be free from defects in material or workmanship for the warranty period specified below:

| | | |
|--------------------------------|------------------------------|--|
| SENCO® XP Series Five years | SENCO PRO Series One year | SENCO Compressors One year |
| SENCO DuraSpin® One year | SENCO Cordless Two years | SENCO Reconditioned Products One Year |

During the warranty period (which begins on the purchase date), SENCO will repair or replace, at SENCO's option and expense, any product or part that is defective in materials or workmanship after examination by a SENCO Authorized Warranty Service Center, subject to the exceptions, exclusions and limitations described below. Any replacement product or part will carry a warranty for the balance of the warranty period applicable to the replaced product or part. A DATED SALES RECEIPT OR PROOF OF PURCHASE FROM THE ORIGINAL RETAIL PURCHASER IS REQUIRED TO MAKE A WARRANTY CLAIM. Warranty registration also is required and can be accomplished through on-line Product Registration at www.senco.com or by completing and returning the postage paid warranty registration form included with your Operator's manual/parts chart information, found inside the product carton. To make a warranty claim, you must return the product, with proper receipt/proof of purchase and return transportation charges prepaid, to a SENCO Authorized Warranty Service Center. A list of SENCO Authorized Warranty Service Centers can be found at www.senco.com or by calling 1-800-543-4596 toll free. SENCO will perform its obligations under this warranty, within a reasonable time after approval of the warranty claim.

Wheelbarrow Compressors:

1. Subject to the exceptions, exclusions and limitations described below, SENCO warrants that the compressor pump will be free from defects in materials and workmanship for two years after the purchase date.
2. Defective parts of the compressor pump not subject to normal wear and tear will be repaired or replaced, at SENCO's option, during the two year warranty period. If SENCO determines that repair or replacement is not feasible, SENCO will refund the purchase price less reasonable depreciation based on actual use.

SENCO Cordless:

1. Subject to the exceptions, exclusions and limitations described below, SENCO warrants that the SENCO Cordless tool will be free from defects in materials and workmanship for two years after the purchase date.
2. SENCO warrants that the batteries and chargers used with SENCO Cordless tools will be free from defects in material and workmanship for one year after the purchase date.

WARRANTY EXCLUSIONS

The following warranty exclusions apply:

1. Normal wear parts are not covered under this warranty. Normal wear parts include, for example, isolators, drive belts, air filters, rubber o-rings, seals, driver blades, piston stops, and piston/driver assembly.
2. This warranty does not cover parts damaged due to normal wear, misapplication, misuse, accidents, operation at other than recommended speeds or voltage (electric units only), improper storage, or damage resulting during shipping.
3. Products used in production/industrial applications as defined by SENCO are excluded from this warranty.
4. Labor charges or loss or damage resulting from improper operation, maintenance or repairs are not covered by this warranty.
5. SENCO does not warrant the Wheelbarrow Compressor Engine/Motor, but the Compressor Engine/Motor may be covered under a warranty offered by its manufacturer.

GENERAL WARRANTY CONDITIONS

This warranty will be honored, only if:

- A. Clean, dry, regulated compressed air has been used, at air pressure not exceeding the maximum indicated on the tool casting;
- B. No evidence of abuse, abnormal conditions, accident, neglect, misuse or improper modifications or storage of the product; and
- C. No Deviation from operating instructions, specifications, and maintenance schedules exists (read Operator Manual for use, specifications, and maintenance instructions).

THIS WARRANTY IS THE ONLY WARRANTY ON THE PRODUCT, AND SENCO DISCLAIMS ALL OTHER WARRANTIES. ANY IMPLIED WARRANTIES WILL BE LIMITED IN DURATION TO THE APPLICABLE WARRANTY PERIOD SPECIFIED ABOVE. SOME STATES DO NOT ALLOW LIMITATIONS ON HOW LONG AN IMPLIED WARRANTY LASTS, SO THE ABOVE LIMITATION MAY NOT APPLY TO YOU. YOUR REMEDIES ARE SOLELY AND EXCLUSIVELY AS STATED ABOVE. SENCO SHALL IN NO EVENT BE LIABLE FOR INCIDENTAL, CONSEQUENTIAL, INDIRECT, OR SPECIAL DAMAGES. SOME STATES DO NOT ALLOW THE EXCLUSION OR LIMITATION OF INCIDENTAL OR CONSEQUENTIAL DAMAGES, SO THE ABOVE LIMITATION OR EXCLUSION MAY NOT APPLY TO YOU. IN NO EVENT, WHETHER AS A RESULT OF A BREACH OF CONTRACT, WARRANTY, TORT (INCLUDING NEGLIGENCE) OR OTHERWISE, SHALL SENCO'S LIABILITY EXCEED THE PRICE OF THE PRODUCT WHICH HAS GIVEN RISE TO THE CLAIM OR LIABILITY. ANY LIABILITY CONNECTED WITH THE USE OF THIS PRODUCT SHALL TERMINATE UPON THE EXPIRATION OF THE WARRANTY PERIOD SPECIFIED ABOVE. NO EMPLOYEE OR REPRESENTATIVE OF SENCO OR ANY DISTRIBUTOR OR DEALER IS AUTHORIZED TO MAKE ANY CHANGE OR MODIFICATION TO THIS WARRANTY.

This warranty gives you specific legal rights, and you may also have other rights which vary from state to state.

REPLACEMENT OF TOOL DUE TO NATURAL DISASTER

SENCO will replace any tool destroyed by an Act of God such as flood, earthquake, hurricane or other disaster resulting only from the forces of nature. Such a claim will be honored provided that such original retail purchaser had previously submitted a completed warranty registration card for the tool, and then submits proof of ownership and an acceptable statement describing such Act of God documented by an insurance carrier, police department, or other official governmental source. To obtain instructions for filing a claim call 1-800-543-4596.

CUSTOMER SATISFACTION

One hundred percent customer satisfaction is our #1 goal. If for any reason the product does not perform to the original purchaser's satisfaction, it can be returned to the place of purchase **within thirty days** with dated sales receipt for a full refund of the purchase price.