

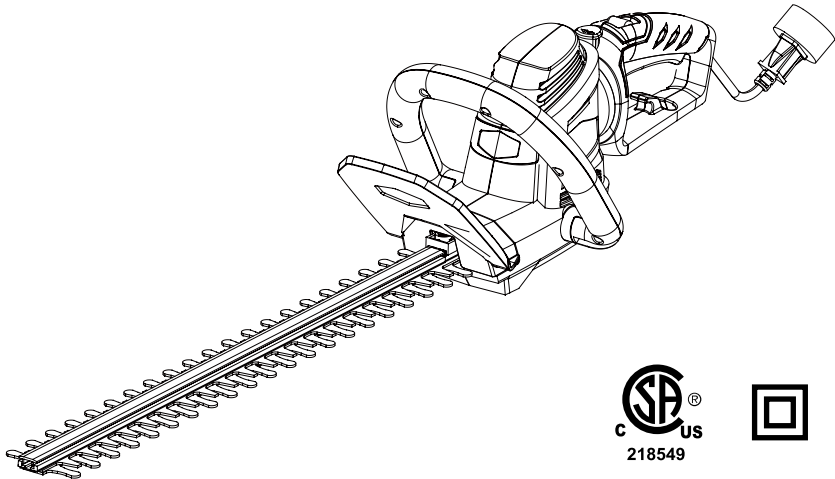

22" 4.0A ROTATING HEDGE TRIMMER  
22122



Owner's Manual

**TOLL-FREE HELPLINE: 1-888-90WORKS** (888.909.6757)  
[www.GreenWorksTools.com](http://www.GreenWorksTools.com)

---

 Read all safety rules and instructions carefully before operating this tool.

# CONTENTS

---

Contents .....	2
Specifications .....	2
Important Safety Instructions.....	3-4
Specific Safety Rules.....	5
Symbols.....	6-7
Electrical.....	8-9
Know your hedge trimmer.....	10
Assembly.....	11
Operation.....	12-14
Maintenance.....	15-16
Troubleshooting.....	17
Warranty.....	18
Exploded View.....	19
Parts List.....	20

# SPECIFICATIONS

---

## 22" 4.0A ELECTRIC HEDGE TRIMMER

Motor .....	120 V AC, 60 Hz, 4.0 A
Reciprocating Speed.....	3,200 SPM
Blade Length .....	22in. (55.9 cm)
Unit Weight.....	6.06 lbs (2.75 Kg)
Cutting Capacity.....	5/8in. (15.9mm)



# IMPORTANT SAFETY INSTRUCTIONS

---

## **READ AND UNDERSTAND ALL INSTRUCTIONS.**

Failure to follow all instructions listed below may result in electric shock, fire, and/or serious personal injury.

## **READ THESE INSTRUCTIONS BEFORE USING THE HEDGE TRIMMER**

- Do not operate power tools in explosive atmospheres, such as in the presence of flammable liquids, gases, or dust. Power tools create sparks which may ignite the dust or fumes.
- To reduce the risk of electric shock, this tool has a polarized plug (one blade is wider than the other). This plug will fit into the polarized wall outlet only one way. If the plug does not fit fully into the wall outlet, reverse the plug. If the plug still does not fit, contact a qualified electrician to install the proper wall outlet. Do not change the plug in any way.
- Avoid body contact with grounded surfaces such as pipes, radiators, ranges, and refrigerators. There is an increased risk of electric shock if your body is grounded.
- Don't expose power tools to rain or wet conditions. Water entering a power tool will increase the risk of electric shock.
- Do not expose to rain; store indoors.
- Do not use in wet conditions.
- Do not handle plug or tool with wet hands.
- Use outdoor extension cords marked W-A, W, SW-A, SOW-A, STW-A, STOW-A, SJW-A, SJTW-A, or SJTOW-A. These cords are rated for outdoor use and reduce the risk of electric shock.
- Never allow children to operate the equipment. Never allow adults to operate the equipment without proper instruction.
- Keep all bystanders, children, and pets at least 50 ft. away.
- Always wear safety glasses with side shields. Everyday glasses have only impact resistant lenses. They are NOT safety glasses. Following this rule will reduce the risk of eye injury. Use face mask if operation is dusty.
- Wear eye protection which is marked to comply with ANSI Z87.1 when operating this product.
- Use extra care when cleaning on stairs.
- Do not leave appliance plugged in. Unplug from outlet when not in use and before servicing.
- Use only as described in this manual. Use only manufacturer's recommended attachments.
- Use only identical manufacturer's replacement parts and accessories. Use of any other parts may create a hazard or cause product damage.
- Keep hair, loose clothing, fingers and all body parts away from openings and moving parts.
- Secure long hair so it is above shoulder level to prevent entanglement in any moving parts.
- Wear heavy long pants, boots, and gloves. Avoid loose garments or jewelry that could get caught in moving parts of the machine or its motor.
- Use non-slip, heavy-duty protective gloves when operating the hedge trimmer and when installing or removing blades.
- Do not operate the equipment while barefoot or when wearing sandals or similar lightweight footwear. Wear protective footwear that will protect your feet and improve your footing on slippery surfaces.

# IMPORTANT SAFETY INSTRUCTIONS

---

- Do not force tool. Use the correct tool for your application. The correct tool will do the job better and safer at the rate for which it is designed.
- Keep firm footing and balance. Do not overreach. Overreaching can result in loss of balance.
- Turn off all controls before unplugging.
- Avoid accidental starting. Be sure the power switch is not on before plugging in. Turn off power switch before unplugging.
- Do not use tool if switch does not turn it on or off. Any tool that cannot be controlled with the switch is dangerous and must be repaired.
- Do not use with damaged plug. If tool is not working as it should or has been dropped, damaged, left outdoors, or dropped into water, return it to an authorized service center.
- Do not operate this unit when you are tired, ill, or under the influence of alcohol, drugs, or medication.
- Do not operate in poor lighting.
- Keep all parts of your body away from any moving parts and all hot surfaces of the unit.
- Do not put any object into openings. Do not use with any opening blocked; keep openings free of dust, lint, hair, and anything that may reduce air flow.
- Check the work area before each use. Remove all objects such as rocks, broken glass, nails, wire, or string which can be thrown or become entangled in the machine.
- Do not pull or carry by cord, use cord as a handle, close a door on a cord, or pull cord around sharp edges or corners. Do not run appliance over cord. Keep cord away from heated surfaces.
- Do not unplug by pulling on cord. To unplug, grasp the plug, not the cord.
- Do not handle plug or appliance with wet hands.
- Do not use with damaged cord or plug. If appliance is not working as it should, has been dropped, damaged, left outdoors, or dropped into water, return it to a service center.
- If the power supply cord is damaged, it must be replaced only by the manufacturer or by an authorized service center to avoid risk.
- Service on the product must be performed by qualified repair personnel only. Service or maintenance performed by unqualified personnel could result in injury to the user or damage to the product.
- In a double insulated appliance, two systems of insulation are provided instead of grounding. No grounding means is provided on a double insulated appliance, nor should a means for grounding be added to the appliance. Servicing a double insulated appliance requires extreme care and knowledge of the system and should be done only by qualified service personnel. Replacement parts for a double insulated appliance must be identical to the parts they replace.
- Not intended for commercial use.

**SAVE THESE INSTRUCTIONS**

---

# SPECIFIC SAFETY RULES

---

- Replace any blade that has been damaged. Always make sure blade is installed correctly and securely fastened before each use. Failure to do so can cause serious injury.
- Never cut any material over 5/8 in.
- Maintain a firm grip on both handles while cutting with a blade. Keep the blade away from body.
- Know how to stop the unit quickly in an emergency.
- Do not use trimmer without front handles in place. Keep both hands on handles when the unit is in use.
- If hedge trimmer is equipped with a clipping deflector, do not use the clipping deflector as a gripping surface. Disconnect the plug from power source before making any adjustments, changing accessories, or storing the hedge trimmer. Such preventive safety measures reduce the risk of starting the product accidentally.
- Save these instructions. Refer to them frequently and use them to instruct others who may use this tool. If you loan someone this tool, loan them these instructions also to prevent misuse of the product and possible injury.

## PROPOSITION 65

---

### **W A R N I N G**

Some dust created by power sanding, sawing, grinding, drilling, and other construction activities contains chemicals known to cause cancer, birth defects or other reproductive harm. Some examples of these chemicals are:









- Lead from lead-based paints
  - Crystalline silica from bricks and cement and other masonry products
  - Arsenic and chromium from chemically-treated lumber Your risk from these exposures varies, depending on how often you do this type of work. To reduce your exposure to these chemicals: work in a well ventilated area, and work with approved safety equipment, such as those dust masks that are specially designed to filter out microscopic particles
- 

**SAVE THESE INSTRUCTIONS**

---

# SYMBOLS



Some of the following symbols may be used on this product. Please study them and learn their meaning. Proper interpretation of these symbols will allow you to operate the product better and safer.

SYMBOL	NAME	DESIGNATION/EXPLANATION
V	Volts	Voltage
A	Amperes	Current
Hz	Hertz	Frequency (cycles per second)
W	Watt	Power
min	Minutes	Time
~	Alternating Current	Type of current
≡	Direct Current	Type or a characteristic of current
	Class II Construction	Double-insulated construction
	Wet Conditions Alert	Do not expose to rain or use in damp locations
	Read The Operator's Manual	To reduce the risk of injury user must read and understand operator's manual before using this product.
	Safety Alert	Precautions that involve your safety.
	Keep Bystanders Away	Keep all bystanders at least 50 ft. away.
	Eye Protection	Always wear safety goggles or safety glasses with side shields and, as necessary, a full face shield when operating this product.
	Ricochet	Thrown objects can ricochet and result in personal injury or property damage.
	Sharp Blade	Do not install or use any type of blade on a product displaying this symbol.

# SYMBOLS

---

The following signal words and meanings are intended to explain the levels of risk associated with this product.

SYMBOL	SIGNAL	MEANING
	<b>DANGER</b>	Indicates an imminently hazardous situation, which, if not avoided, will result in death or serious injury.
	<b>WARNING</b>	Indicates a potentially hazardous situation, which, if not avoided, could result in death or serious injury.
	<b>CAUTION</b>	Indicates a potentially hazardous situation, which, if not avoided, may result in minor or moderate injury.
	<b>CAUTION</b>	(Without Safety Alert Symbol) Indicates a situation that may result in property damage.

## SERVICE

Service requires extreme care and knowledge and should be performed only by a qualified service technician. For service we suggest you return the product to your nearest **AUTHORIZED SERVICE CENTER** for repair. When servicing, use only identical replacement parts.

---

### **W A R N I N G**

To avoid serious personal injury, do not attempt to use this product until you read thoroughly and understand completely the operator's manual. If you do not understand the warnings and instructions in the operator's manual, do not use this product. Call GREENWORKS customer service for assistance.

---

---

### **W A R N I N G**



The operation of any power tool can result in foreign objects being thrown into your eyes, which can result in severe eye damage. Before beginning power tool operation, always wear safety goggles or safety glasses with side shields and, when needed, a full face shield. We recommend Wide Vision Safety Mask for use over eyeglasses or standard safety glasses with side shields. Always use eye protection which is marked to comply with ANSI Z87.1.

---

# ELECTRICAL

---

## **⚠ WARNING**

TO AVOID ELECTRICAL HAZARDS, FIRE HAZARDS, OR DAMAGE TO THE TOOL, USE PROPER CIRCUIT PROTECTION. YOUR HEDGE TRIMMER IS WIRED AT THE FACTORY FOR 120V OPERATION. CONNECT TO A 120V, 15A CIRCUIT AND USE A 15A TIME-DELAYED FUSE OR CIRCUIT BREAKER. TO AVOID SHOCK OR FIRE IF THE POWER CORD IS WORN, CUT OR DAMAGED IN ANY WAY, REPLACE IT IMMEDIATELY.

---

## **DOUBLE INSULATED** (See Figure 1.)

This hedge trimmer has a plug that looks like the one shown in Fig. 1. The hedge trimmer is double insulated to provide a double thickness of insulation between you and the tool's electrical system. All exposed metal parts are isolated from the internal metal motor components with protective insulation.

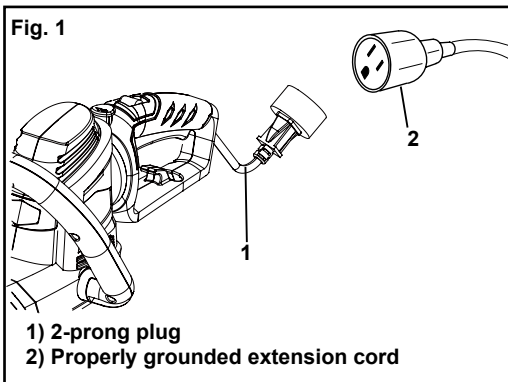

## **⚠ WARNING**

USE ONLY IDENTICAL REPLACEMENT PARTS WHEN SERVICING THE HEDGE TRIMMER, TO AVOID INJURY.

---

## **⚠ WARNING**

DOUBLE INSULATION DOES NOT TAKE THE PLACE OF NORMAL SAFETY PRECAUTIONS WHEN OPERATING THIS TOOL.

---

## **⚠ WARNING**

TO AVOID ELECTRIC SHOCK:

- Use only identical replacement parts when servicing a tool with double insulation. Servicing should be performed by a qualified technician.
  - Do not use in wet or damp areas or expose to rain.
-



# ELECTRICAL

---

## GROUNDING INSTRUCTIONS

IN THE EVENT OF A MALFUNCTION OR BREAKDOWN, grounding provides the path of least resistance for electric current and reduces the risk of electric shock. This tool is equipped with an electric cord that has a POLARIZED plug. The power cord MUST be plugged into a matching outlet that is properly installed and grounded in accordance with ALL local codes and ordinances. DO NOT MODIFY THE PLUG PROVIDED. If it will not fit the outlet, have the proper outlet installed by a qualified electrician.

---

### CAUTION

ALWAYS MAKE SURE THAT YOUR OUTLET IS PROPERLY GROUNDED. IF UNCERTAIN, HAVE IT CHECKED BY A CERTIFIED ELECTRICIAN.

---

### WARNING

THIS HEDGE TRIMMER IS FOR OUTDOOR USE ONLY. DO NOT EXPOSE TO RAIN OR USE IN DAMP LOCATIONS.

---

## GUIDELINES FOR USING EXTENSION CORDS

USE THE PROPER EXTENSION CORD. Make sure your extension cord is in good condition. When using an extension cord, be sure to use one of heavy enough gauge to carry the current your product will draw. An undersized cord will cause overheating. The table below shows the correct size to use depending on cord length and nameplate ampere rating. If in doubt, use the next heavier gauge. The smaller the gauge number, the heavier the cord. Make sure your extension cord is properly wired and in good electrical condition. Always replace a damaged extension cord or have it repaired by a qualified person before using it. Keep your extension cords away from sharp objects, excessive heat and damp or wet areas.

Use a separate electrical circuit for your tools. This circuit should not be less than #12 wire and should be protected with a 15A time delayed fuse. Before connecting the motor to the power line, make sure the switch is in the OFF position and the electric current is rated the same as the current stamped on the motor nameplate. Running at a lower voltage will damage the motor.

---

### WARNING

ALTHOUGH THIS TOOL IS DOUBLE INSULATED, THE EXTENSION CORD AND RECEPTACLE MUST STILL BE GROUNDED WHILE IN USE TO PROTECT THE OPERATOR FROM ELECTRICAL SHOCK.

---

### MINIMUM GAUGE FOR EXTENSION CORDS (AWG) (WHEN USING 120 V ONLY)

Amp Rating		Total Length of Cord in Feet (meters)			
More Than	Not More Than	25' (7.6 m)	50' (15 m)	100' (30.4 m)	150' (45.7 m)
0	6	18	16	16	14
6	10	18	16	14	12
10	12	16	16	14	12
12	16	14	12	Not Recommended	

---

# KNOW YOUR HEDGE TRIMMER

The safe use of this product requires an understanding of the information on the product and in this operator's manual as well as a knowledge of the project you are attempting. Before use of this product, familiarize yourself with all operating features and safety rules. (See Figure 2.)

## CORD RETAINER

A convenient cord retainer helps keep the extension cord connection secure during trimmer operation.

## GUARD

The guard helps to deflect chips or other debris away from the operator's hands.

## TRIGGER SWITCH AND LOCK OFF BUTTON

The trigger switch, located beneath the rear handle, and the lock-off button, located behind the front handle, must be depressed simultaneously to allow blade rotation. Lock-off switch may be released once hedge trimmer is running.

## ROTATING HANDLE

The handle of your hedge trimmer rotates 90 degrees to the left or right for control and precision trimming.

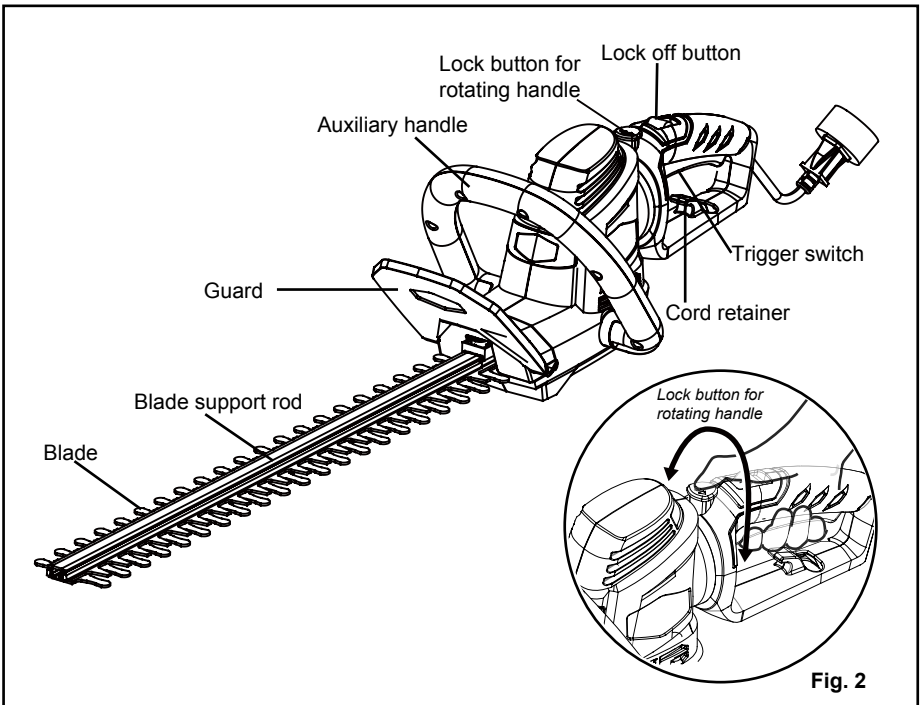

Fig. 2

# ASSEMBLY

---

## UNPACKING

- This product requires no assembly.
- Carefully remove the product and any accessories from the box. Make sure that all items listed in the packing list are included.
- Inspect the product carefully to make sure no breakage or damage occurred during shipping.
- Do not discard the packing material until you have carefully inspected and satisfactorily operated the product.
- If any parts are damaged or missing, please call **1-888- 909-6757** for assistance.

## PACKING LIST

- Electric hedge trimmer
- Operator's manual

---

### **W A R N I N G**

If any parts are damaged or missing, do not operate this product until the parts are replaced. Failure to heed this warning could result in serious personal injury.

---

---

### **W A R N I N G**

Do not attempt to modify this product or create accessories not recommended for use with this product. Any such alteration or modification is misuse and could result in a hazardous condition leading to possible serious personal injury.

---

---

### **W A R N I N G**

Do not connect to power supply until assembly is complete. Failure to comply could result in accidental starting and possible serious personal injury.

---

# OPERATION

---

## **⚠ WARNING**

Do not allow familiarity with this product to make you careless. Remember that a careless fraction of a second is sufficient to inflict serious injury.

---

## **⚠ WARNING**

Always wear safety goggles or safety glasses with side shields when operating power tools. Failure to do so could result in objects being thrown into your eyes, resulting in possible serious injury.

---

## **⚠ WARNING**

Do not use any attachments or accessories not recommended by the manufacturer of this product. The use of attachments or accessories not recommended can result in serious personal injury.

---

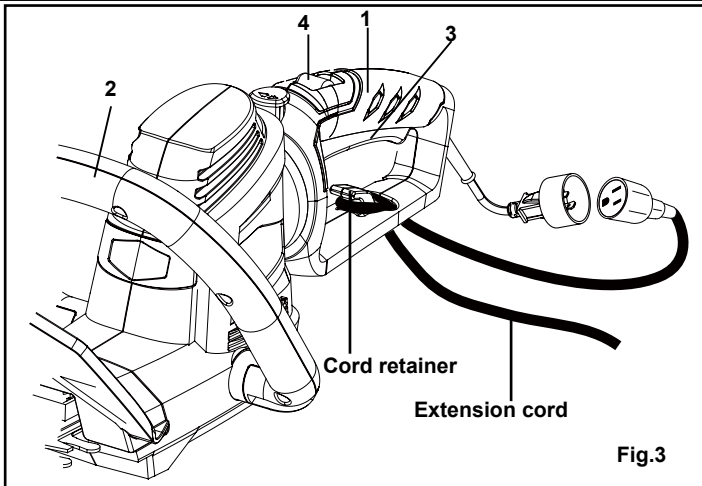

## **CONNECTING TO POWER SUPPLY**

This product is designed with a cord retainer that prevents the extension cord from being pulled loose while using.

- Form a loop with the end of the extension cord.
- Insert loop portion of extension cord through opening in the bottom of the rear handle and place over cord retainer.
- Slowly pull loop against cord retainer until the slack is removed. (Fig.3)
- Plug product into extension cord.

*NOTE: Failure to remove all excess cord slack from extension cord retainer could result in plug loosening from receptacle.*

---

# OPERATION

---

## **STARTING THE HEDGE TRIMMER** (See Figure 3.)

1. Attach an extension cord to your hedger.
2. Place one hand on the trigger handle (1). Place the other hand on the auxiliary handle (2).
3. Slide the lock switch (4) backwards you then squeeze the trigger switch (3) to turn ON the hedge trimmer. The trimmer will stay on as long as the trigger switch is squeezed. Lock-off switch may be released once hedge trimmer is running.

## **STOPPING THE HEDGE TRIMMER** (See Figure 3.)

1. Release the trigger switch (3).
2. Allow at least 5 seconds for the cutting blade to stop moving.

## **USING THE ROTATING REAR HANDLE**(See Figure 4 )

1. Place the hedge trimmer on a flat and even surface and disconnect from the power supply.
2. Make sure that you released the trigger.
3. Press the lock button and begin turning the rear handle. Release the lock button and turn the handle 90 degrees to either side until it clicks into place and the button pops out.
4. To turn the handle back to center, press the lock button again, turn the handle slightly, release the lock button and continue turning the handle until it locks into place.

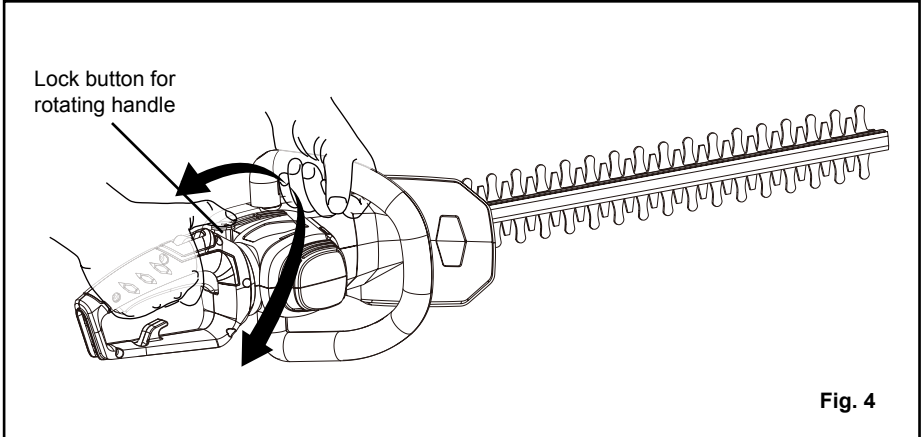

# OPERATION

---

## CUTTING TIPS

---

### **W A R N I N G**

Always keep both hands on the hedge trimmer handles. Never hold shrubs with one hand and operate hedge trimmer with the other. Failure to heed this warning can result in serious injury.

---

### **W A R N I N G**

Clear the area to be cut before each use. Remove all objects such as cords, lights, wire, or loose string which can become entangled in the cutting blade and create a risk of serious personal injury.

---

- When operating the hedge trimmer, keep the extension cord behind the trimmer. Never drape it over the hedge being trimmed.
  - Do not force the hedge trimmer through heavy shrubbery. This can cause the blades to bind and slow down. If the blades slow down, reduce the pace.
  - Do not attempt to cut stems or twigs that are larger than 3/8 in., or those obviously too large to feed into the cutting blade. Use a non-powered hand saw or pruning saw to trim large stems.
  - If blades do become jammed, stop the motor, allow the blades to stop, and disconnect the plug from the power source before attempting to remove the obstruction.
  - If desired, you can use a string to help cut your hedge level. Decide how high you want the hedge. Stretch a piece of string along the hedge at the desired height. Trim the hedge just above the guide line of string. Trim the side of a hedge so that it will be slightly narrower at the top. More of the hedge will be exposed when shaped this way, and it will be more uniform.
  - Wear gloves when trimming thorny or prickly growth. When trimming new growth, use a wide sweeping action, so that the stems are fed directly into the cutting blade. Older growth will have thicker stems and will be trimmed easiest by using a sawing movement.
- 

### **W A R N I N G**

Read the safety information for safe operation using the blade. Extreme care must be taken when using blades to ensure safe operation. Refer to Important Safety Instructions and Specific Safety Rules (See pages 3 - 5)

---

The unit is used for cutting in either direction in a slow, sweeping action from side to side.

- Stand so that you are stable and balanced on both feet. Do not overreach.
  - Inspect and clear the area of any hidden objects.
  - Never use the hedge trimmer near power lines, fencing, posts, buildings, or other immovable objects.
  - Never use a blade after hitting a hard object without first inspecting it for damage. Do not use if any damage is detected.
  - Never touch blades or service unit with the power supply connected.
-

# MAINTENANCE

---

---

## **⚠ WARNING**

WHEN SERVICING, USE ONLY IDENTICAL REPLACEMENT PARTS. USE OF ANY OTHER PARTS MAY CREATE A HAZARD OR CAUSE PRODUCT DAMAGE.

---

---

## **⚠ WARNING**

ALWAYS WEAR SAFETY GOGGLES OR SAFETY GLASSES WITH SIDE SHIELDS DURING PRODUCT OPERATION. IF OPERATION IS DUSTY, ALSO WEAR A DUST MASK.

---

---

## **⚠ WARNING**

BEFORE INSPECTING, CLEANING, OR SERVICING THE MACHINE, DISCONNECT THE PLUG FROM POWER SOURCE AND WAIT FOR ALL MOVING PARTS TO STOP. FAILURE TO FOLLOW THESE INSTRUCTIONS CAN RESULT IN SERIOUS PERSONAL INJURY OR PROPERTY DAMAGE.

---

---

## **⚠ WARNING**

DO NOT AT ANY TIME LET BRAKE FLUIDS, GASOLINE, PETROLEUM-BASED PRODUCTS, PENETRATING OILS, ETC., COME IN CONTACT WITH PLASTIC PARTS. CHEMICALS CAN DAMAGE, WEAKEN, OR DESTROY PLASTIC WHICH MAY RESULT IN SERIOUS PERSONAL INJURY. ONLY THE PARTS SHOWN ON THE PARTS LIST ARE INTENDED TO BE REPAIRED OR REPLACED BY THE CUSTOMER. ALL OTHER PARTS SHOULD BE REPLACED AT AN AUTHORIZED SERVICE CENTER.

---

---

## **⚠ WARNING**

BLADES ARE SHARP. WHEN HANDLING THE BLADE ASSEMBLY, WEAR NON-SLIP, HEAVY-DUTY PROTECTIVE GLOVES. DO NOT PLACE YOUR HAND OR FINGERS BETWEEN BLADES OR IN ANY POSITION WHERE THEY COULD GET PINCHED OR CUT. NEVER TOUCH BLADES OR SERVICE UNIT WITH THE POWER SUPPLY CONNECTED.

---

## **GENERAL MAINTENANCE**

Avoid using solvents when cleaning plastic parts. Most plastics are susceptible to damage from various types of commercial solvents and may be damaged by their use. Use clean cloths to remove dirt, dust, oil, grease, etc.

# MAINTENANCE

---

## **CLEANING THE HEDGE TRIMMER**

- Stop the motor and disconnect from power supply.
- Clean dirt and debris from the body of the hedge trimmer, using a damp cloth with a mild detergent.

---

*NOTE: Do not use any strong detergents on the plastic housing or the handle. They can be damaged by certain aromatic oils such as pine and lemon, and by solvents such as kerosene.*

## **STORING THE TRIMMER**

- Clean all foreign material from the product.
- Store it in a well-ventilated place that is inaccessible to children.
- Keep away from corrosive agents such as garden chemicals and de-icing salts.



# TROUBLESHOOTING

---

<b>PROBLEM</b>	<b>POSSIBLE CAUSE</b>	<b>SOLUTION</b>
Unit will not start.	1. Cord not plugged in. 2. Cord or switch is damaged.	1. Plug in cord. 2. Have cord or switch replaced.
Motor runs, but cutting blades do not move.	Hedge trimmer damaged. Do not use hedge trimmer.	Call for technical service.
Hedge trimmer smokes during operation.	Hedge trimmer damaged. Do not use hedge trimmer.	Call for technical service.

# LIMITED FOUR-YEAR WARRANTY

---



GREENWORKS™ hereby warrants this product, to the original purchaser with **proof of purchase**, for a period of four (4) years against defects in materials, parts or workmanship. GREENWORKS™, at its own discretion will repair or replace any and all parts found to be defective, through normal use, free of charge to the customer. This warranty is valid only for units which have been used for personal use that have not been hired or rented for industrial/commercial use, and that have been maintained in accordance with the instructions in the owners' manual supplied with the product from new.

## ITEMS NOT COVERED BY WARRANTY:

1. Any part that has become inoperative due to misuse, commercial use, abuse, neglect, accident, improper maintenance, or alteration; or
2. The unit, if it has not been operated and/or maintained in accordance with the owner's manual; or
3. Normal wear, except as noted below;
4. Routine maintenance items such as lubricants, blade sharpening;
5. Normal deterioration of the exterior finish due to use or exposure.

## GREENWORKS HELPLINE (1 888 90WORKS):

Warranty service is available by calling our toll-free helpline, 9am to 5pm EST. Monday – Friday at **1-888-909-6757 (1-888-90WORKS)**.

## TRANSPORTATION CHARGES:

Transportation charges for the movement of any power equipment unit or attachment are the responsibility of the purchaser. It is the purchaser's responsibility to pay transportation charges for any part submitted for replacement under this warranty unless such return is requested in writing by GREENWORKS.

# EXPLODED VIEW

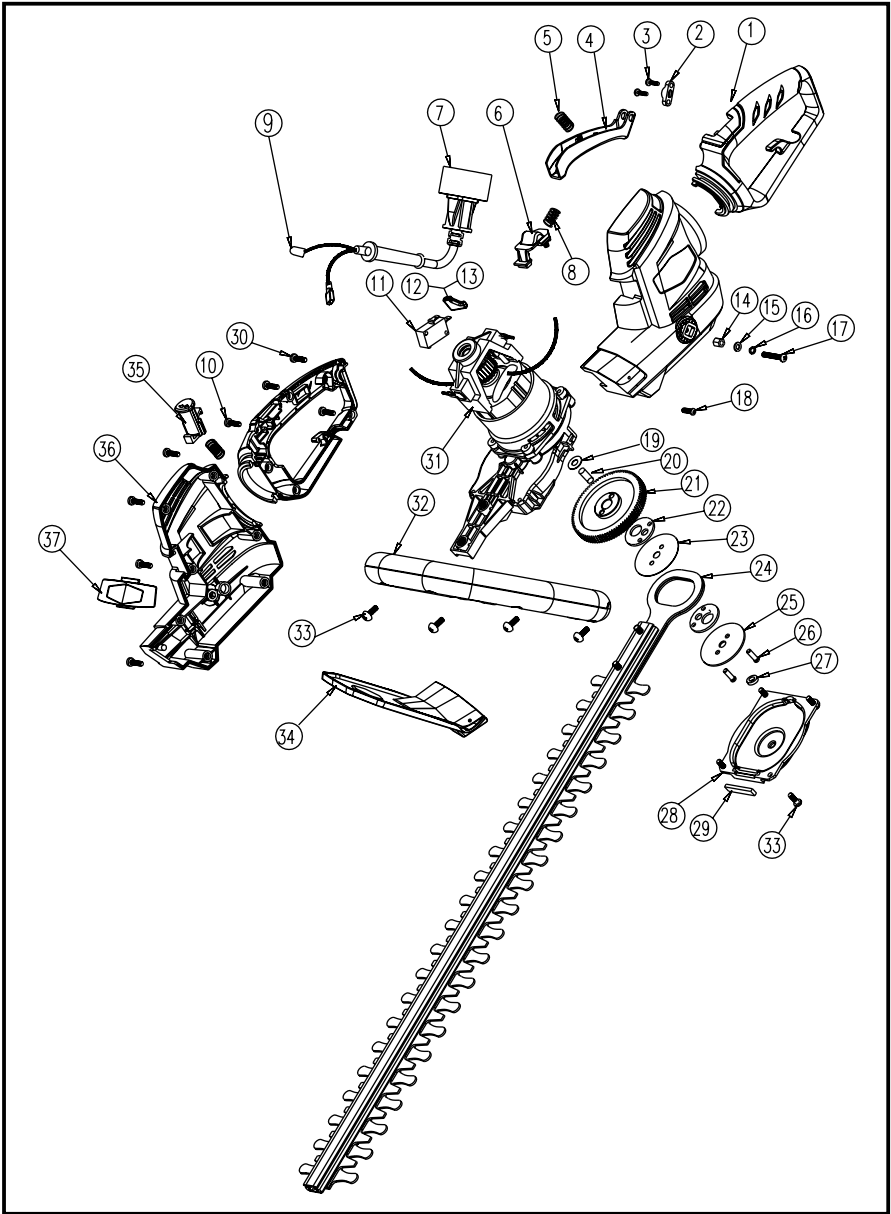

# PARTS LIST

---

ITEM NO.	PART NO.	DESCRIPTION	QTY
1	34102456	handle assembly	1
2	34118441	cord clamp	1
3	32201441	screw	2
4	34106456	switch trigger	1
5	33402161-1	spring	2
6	34109453-1	button	1
7	31102456	plug assembly	1
8	3340287	spring	1
9	36504161	wiring cap	1
10	3220345	screw	1
11	36303152	switch	1
12	34903161	sleeve	2
13	3650201	terminal	2
14	3250186	nut	2
15	3290186	washer	2
16	3290675	washer	2
17	32201162	screw	2
18	3220187	screw	2
19	33302161	washer	1
20	33203161	bearing HK061009	1
21	33208161	pin	1
22	33302162	eccentric block	2
23	33304161	isolating plate	1
24	31101456	blade assembly	1
25	33305161	washer	1
26	33203161	pin	2
27	33203162	liner	1
28	34103161	gear case cover	1
29	34902161	felt	1
30	3220313	screw	4
31	36101162-1	motor	1
32	31302162-3	auxiliary handle assembly	1
33	3220905	screw	10
34	34103456	guard	1
35	34105456	button for rotating the head	1
36	34101456	housing	1
37	34104456	decoration board	1



**TOLL-FREE HELPLINE: 1-888-90WORKS** (888.909.6757)

Rev: 01 (06-15 -12)

 Printed in China on 100% Recycled Paper